



United States
Department of
Agriculture

Agricultural
Marketing
Service

Fruit and
Vegetable
Programs

Fresh Products
Branch

January 1966

General

Shipping Point Inspection Instructions

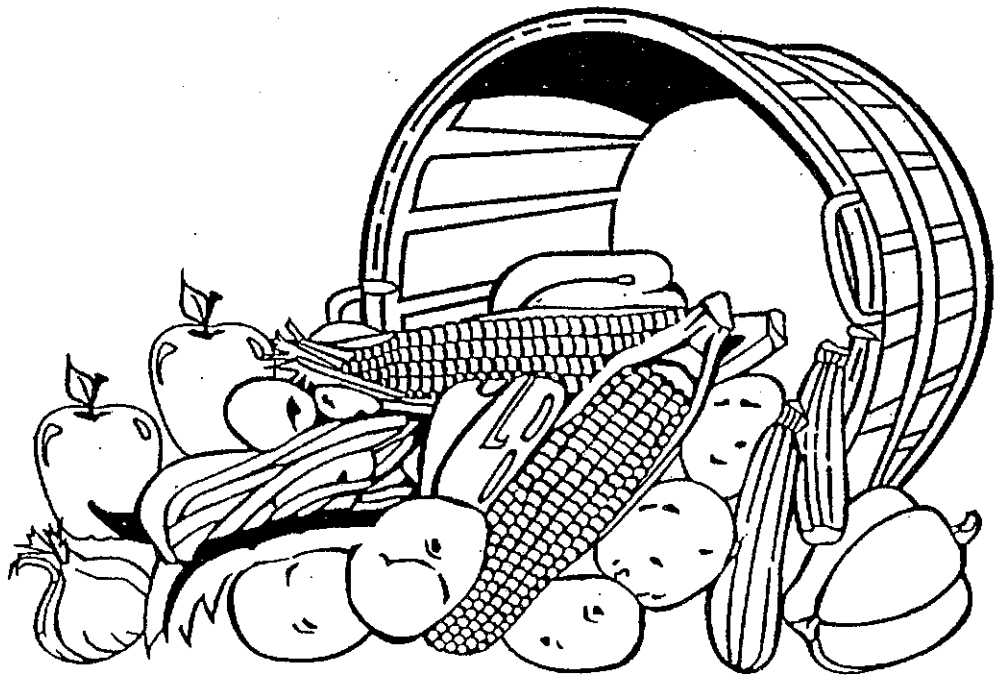

HA-151
HA-155 7/7/11
e

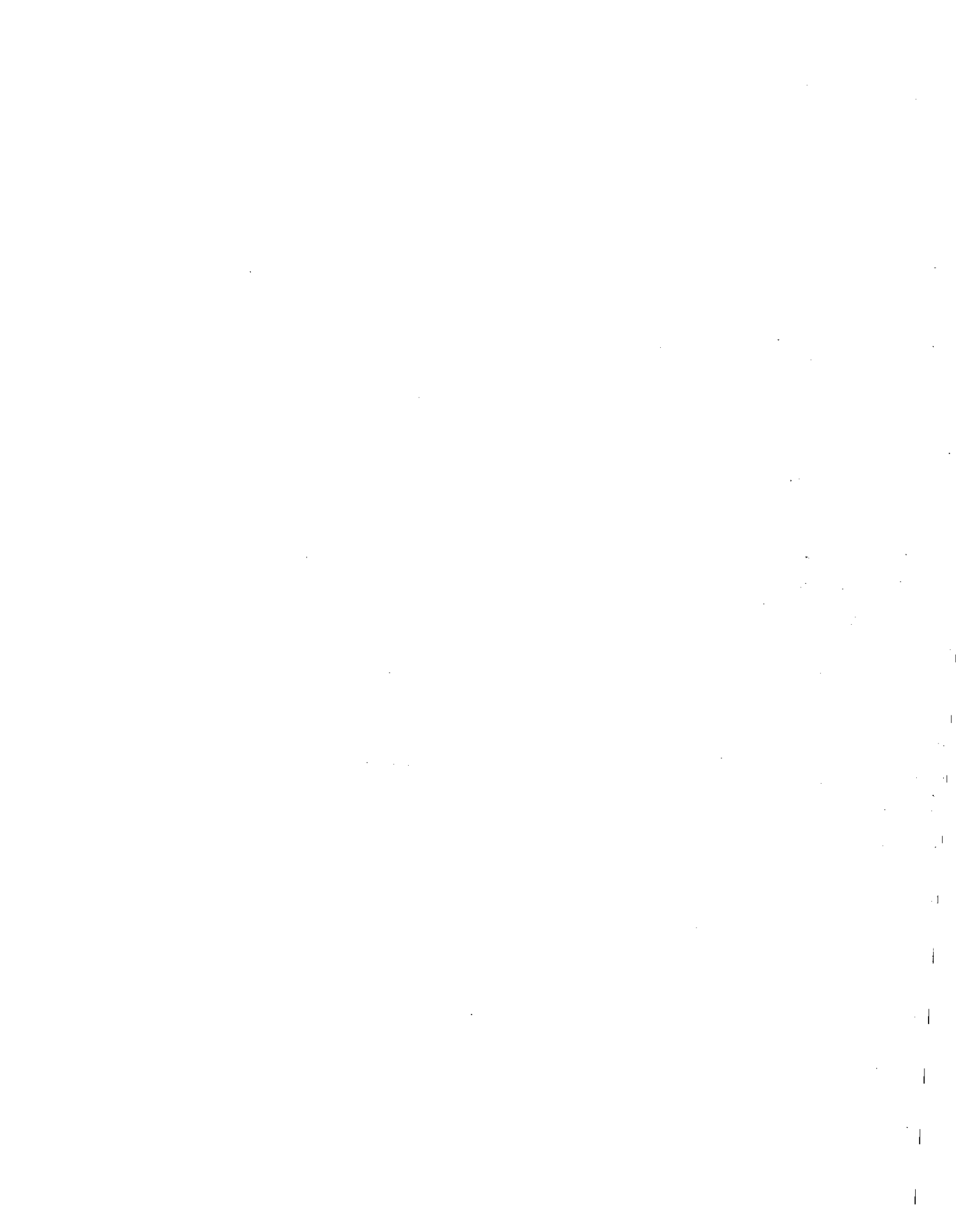

TABLE OF CONTENTS

PART I

	<u>PARAGRAPH(S)</u> <u>NUMBERS</u>
Introduction	1
Fundamental Principles of Inspection	2 - 4
Strict Adherence to Directions	5 - 7
Authority for the Inspection Service	8 - 9
Policy for Inspections of Imported/Interstate Shipments	10
Inspectors Have No Regulatory Authority	11
Relation of the Inspector to the Trade	12 - 17
Relation of the Inspector with other Inspectors	18 - 20
Rules of Conduct for Inspectors	21 - 26
Borrowers	22
Financial Interest of Inspectors	23
Discreet Speech	24
Observance of "No Smoking" Rules	25
Political Activity	26
Reporting Alleged or Suspected Bribery Attempts	27 - 29
Relation of the Inspector to the Trade-Rules of Conduct	30 - 35
Relation of Inspectors to Carriers	36 - 41
Breaking of Seals and Resealing Containers]	37 - 41
Outside Temperatures	42 - 43
Instructions Relative to Prevention of Injuries	44 - 64
Precautions When Handling Packages	45 - 48
Working in Classification Yards	49
Overhead Wires	50
Opening Carrier Doors	51
Entering and Leaving Carriers and Inspection Bunkers	52
Entering Carriers Subject to Gaseous Elements	53 - 55
Danger of Being Locked in Carriers	56
Climbing into Carriers	57 - 60
Cold Storages	61

II

	PARAGRAPH(S) NUMBERS
When Inspection will Jeopardize Health or Safety	62
First Aid	63 – 64
Inspection Equipment	65 – 70
Scales	66
Thermometers	67 – 68
Lights	69 – 70
For Whom May Inspections Be Made	71 – 73
Application for Inspection	74 – 77
Recording Applications	78
Refusing to Inspect	79 – 80
Making False Use of Official Certificate Marks or Other Identification	81
What the Certificate Covers	82 – 83
Prima Facie Evidence	84
Making the Inspection	85 – 99
Representative Samples	85
Using of Manifest Records	86
Deceptive Loading	87
Number of Samples	88
Size of Samples and Average Sample Scorings	89 – 90
Additional Samples	91 – 92
Examine Specimens from Different Places in Container	93 – 94
When Consumer Package is Sample for Inspection	95 – 96
**** Cutting Specimens Policies and Procedures	97 – 97e ****
Recoopering Loads and Packages	98 – 99
Furnishing Information on Shipping Point Inspections	100
Inspector's Notes	101
Reinspection and Marking Carriers	102 – 105
Determining the Kind of Inspection to Make	106 – 109

TABLE OF CONTENTS

PART I

	<u>Paragraph Numbers</u>
INTRODUCTION.....	1
FUNDAMENTAL PRINCIPLES OF INSPECTION.....	2 - 4
AUTHORITY FOR THE INSPECTION SERVICE.....	5 - 9
RELATIONSHIP OF THE INSPECTOR.....	10 - 36
Relationship of the Inspector to the State.....	10 - 11
Relationship of the Inspector to the Federal Dept.	12 - 25
Licensee's Personnel Record Cards.....	14 - 15
Federal License Card.....	16 - 23
Suspension or Revocation of License.....	24
Inspectors Have no Regulatory Authority.....	25
Relation of the Inspector to the Trade.....	26 - 33
Relation of the Inspector with Other Inspectors.....	34 - 36
RULES OF CONDUCT FOR INSPECTORS.....	37 - 42
Borrowers.....	38
Financial Interest of Inspectors.....	39
Discreet Speech.....	40
Observance of "No Smoking" Rules.....	41
Political Activity.....	42
GENERAL INSTRUCTIONS.....	43 - 78
Refusing to Inspect.....	43 - 44
Prima Facie Evidence.....	45 - 47
Attempting Too Many Inspections.....	48
Order of Inspections.....	49 - 50
Responsibility for Condition of Load.....	51
Breaking Seals and Resealing Cars.....	52 - 53
Precaution Against Injury.....	54 - 57
State Serial Lot Numbers.....	58 - 59
Certificates Issued in Connection with the terms of Marketing Agreements.....	60
Inspections Billed to Federal Agencies.....	61
Who is Entitled to Information from Score Sheets.....	62

Paragraph
Numbers

Control of Copies of Market Certificates.....	63
Correspondence Related to Inspections.....	64
Signing the Certificate.....	65
Signature by Supervising Inspectors.....	66 - 68
Power of Attorney.....	69
Blank Certificates Not to be Given the Public.....	70
Marking False Use of Official Certificates, Marks or Other Identification.....	71 - 72
Identity Lost When Lot is Repacked or Reconditioned.....	73
Issuing Two Certificates on Same Car at Shipping Point..	74
Marking of Cars.....	75 - 77
Inspection Service Car Seals.....	78
 REINSPECTIONS IN THE MARKETS.....	 79 - 85
Condition and Confirmation Inspections.....	79 - 80
Appeal Inspections.....	81 - 84
Wiring at Request of Shippers.....	85
 TELEGRAMS.....	 86 - 91
 GIVING OF TESTIMONY BY INSPECTORS.....	 92 - 99
 FOOD AND DRUG PACKAGE MARKING REQUIREMENTS.....	 100 - 109
 PERISHABLE AGRICULTURAL COMMODITIES ACT.....	 110 - 119
Inquiries.....	110 - 111
Misbranding.....	112 - 114
Notify the Regulatory Branch of Misbranding Cases.....	115
PACA Ruling On Grade and Size Markings.....	116 - 119
Off-Count Under PACA.....	118
 CLERICAL AND OFFICE INSTRUCTION REGARDING CERTIFICATES.....	 120 - 145
Typing the Certificate.....	120 - 121
Handwritten Certificates.....	122
Certificate Numbers.....	123 - 127
Date.....	128
Address of Applicant and Shipper.....	129
Arrangement of Text on the Certificate.....	130
Car Initials and Number.....	131

III

	<u>Paragraph Numbers</u>
Words to be Capitalized.....	132 - 133
Apostrophe Marks.....	134
Figures, Percentage Marks.....	135
Sizes.....	136
Abbreviations.....	137
Unused Headings.....	138
Place for Signature of the Inspector.....	139
Initialing by Typist.....	140
Comparing Typed Certificate with Inspector's Notes.....	141 - 142
When More Space Needed on the Certificate.....	143 - 145
 ISSUANCE AND DISTRIBUTION OF COPIES OF INSPECTION CERTIFICATES.....	
	146 - 153
 CORRECTING, VOIDING AND SUPERSEDING CERTIFICATES.....	
	154 - 166
Minor Corrections Made in the Course of Typing or Prior to Issuance.....	155
Correction of Material Errors Prior to Issuance.....	156
Corrections After Issuance.....	157 - 160
Signing or Initialing Corrections.....	161
Notice of Correction Report.....	162 - 164
Corrections Outside the Originating District.....	165 - 166
 FURNISHING REPORTS.....	
	167 - 169
 FURNISHING ADDITIONAL CERTIFICATE COPIES.....	
	170 - 171
Lost Original, Charge for Extra Copies.....	172 - 173
 FURNISHING CERTIFIED COPIES OF CERTIFICATES.....	
	174
 HANDLING CERTIFICATION SUPPLIES.....	
	175 - 182
Accounting for Certificate Forms.....	175 - 176
Distribution of Certification Supplies.....	177 - 180
Keep Accountable Forms in Locked Storage.....	181
Preservation of Certificate Files.....	182

PART II

MAKING THE INSPECTION, KEEPING NOTES, ISSUING REPORTS.....	183 - 251
Sampling.....	183 - 199
Samples From Open Containers.....	187

IV

Paragraph
Numbers

Observations Prior to Packing.....	188
Number of Samples.....	189
Lots Bordering on the Tolerance.....	190
Additional Samples.....	191
Size of Samples.....	192 - 194
Average Sample Scorings.....	195
When Contents of Consumer Package is the Unit for Inspection.....	196
Sampling from Packing Bins.....	197
Cutting Specimens.....	198
Avoid Causing Inconvenience in Making Inspections.....	199
Inspector's Notes.....	200 - 225
Preparing the Score Sheet.....	202
Recording the Scorings.....	203 - 204
Symbols Suggested For Use on Score Sheets.....	205 - 208
Entries Under the Headings Pack, Size, Color, Shape, etc	209
Identifying the Product and Container.....	210
Check Items at Bottom of Score Sheet.....	211
Recording the Car Number.....	212 - 213
Recording Growers' Marks or Lot Numbers.....	214 - 215
Two or More Products In a Car.....	216
Time of Scores on Note Sheets.....	217
Score Sheets for Combination Grade or Unclassified Lots.	218
Recording Defects.....	219 - 220
Recording Pack.....	221
Recording Items Not Shown on the Certificate.....	222
Misrepresentations on Score Sheets.....	223
Giving Out Information from Score Sheets.....	224 - 225
ISSUING PRELIMINARY REPORTS.....	226 - 230
REPORTING DELAYED LOADING.....	231 - 232
INSPECTION COMPLETED ON A LATER DATE.....	233
STATEMENTS SUPPLEMENTING CERTIFICATES.....	234
CORRECTIONS OF INSPECTOR'S NOTES AND CERTIFICATES.....	235 - 239
PREPARATION OF THE LONGHAND DRAFT.....	240 - 241
PREPARATION OF FV-184's AND SHORT OR TRUCK FORM CERTIFICATES.....	242 - 251

Commodity Information That Must be Reported on FV-184 Certificates.....	244
Reporting Additional Information on FV-184 Certificates.	245 - 246
Worksheet Information For FV-184's.....	247 - 248
Correcting Errors on FV-184 Certificates.....	249 - 251

PART III

THE CERTIFICATE.....	252
MODIFYING CERTIFICATE HEADINGS.....	253 - 254
CERTIFICATE NUMBER.....	255
INSPECTION POINT.....	256
KIND OF CAR.....	257
CAR INITIALS AND NUMBER.....	258 - 259
LOTS NOT IDENTIFIED BY CAR NUMBER.....	260 - 269
Lots Identified by Truck Numbers.....	261 - 266
Lots Identified by State Lot or Other Stamps.....	267 - 268
Lots With No Lot Identification.....	269
INSPECTION BEGUN - COMPLETED.....	270 - 277
Truck Lot Certificates Other Than FV-184's.....	277
APPLICANT.....	278
SHIPPER.....	279
CONDITION OF CAR.....	280 - 308
Definition of Terms.....	280
B End.....	281
A End.....	282
"R" Side or Right Side.....	283
"L" Side or Left Side.....	284
Bunkers.....	285
Tanks.....	286
Bunker Bulkheads.....	287
Collapsible Bunkers.....	288

Paragraph
Numbers

Hatches.....	289	
Hatch Covers.....	290	
Plugs.....	291	
Amount of Ice.....	292	
Drain Pipes, Drains, Traps.....	293	
Floor Racks.....	294	
Ribbed Floor.....	295	
False Floor, False Walls.....	296	
Paper Lining.....	297	
Pads and Straw, Hay or Shredded Paper Bedding.....	298	
Heaters.....	299	
Doorway.....	300	
Space Between Doors.....	301	
Doorways Boarded Across or Boards Across Doorway.....	302	
Doorways Slatted.....	303	
Wall Openings Slatted.....	304	
Vents.....	305	
Ventilating Doors, Slat Doors, Screen Doors.....	306	
Solid Doors.....	307	
Defective Equipment.....	308	
PRODUCTS.....	309	- 337
Name of Product.....	310	
Variety, Type or Description.....	311	
Containers, Type or Kind.....	312	- 314
Cell and Tray Packs.....	315	
Consumer Size Packages.....	316	
Cellophane, Pliofilm.....	317	
Brands.....	318	- 321
Growers' Marks and Lot Numbers.....	322	
Grades and Sizes.....	323	
State Lot, Storage Lot or Other Lot Numbers and Stencils.....	324	- 327
Identification by Comparison Terms.....	328	- 330
Quantity Certified.....	331	- 336
Examples of Products Statements.....	337	
LOADING.....	338	- 392
Wiring or Strapping.....	342	
Condition of Packages.....	343	
Warehouse and Storage Lots.....	344	
Standard Terms for Describing Loading and Bracing of Cars.....	345	- 392

VII

Paragraph
Numbers

Layer.....	346
Stack.....	347
Row.....	348
First Layer.....	349
Second Layer.....	350
Stack Numbering.....	351
Incomplete Layer.....	352
Guide Row.....	353
Through Load.....	354
Divided Load.....	355
Lengthwise Loading.....	356
Crosswise Loading.....	357
Upright Loading.....	358
End to End Offset Load.....	359
Crosswise Offset.....	360
Inverted V or Ellis Method.....	361
Side Stripped Load.....	362
Alternately Inverted.....	363
Side Load, Alternately Reversed.....	364
Tunnel Load.....	365
On Bilge.....	366
On Edge.....	367
Diagonal Row.....	368
Staggered Row.....	369
Deck Load.....	370
Loose Load.....	371
Lengthwise Space.....	372
Crosswise Space.....	373
Rows Spaced.....	374
Space at Sides.....	375
Slack.....	376
Crosswise Slack.....	377
Space Filler.....	378
Center Brace, Center Gate, Center Bulkhead.....	379
End Gate, End Brace, End Bulkhead.....	380
Spacing Frame.....	381
Spacing Strips.....	382
Car Strips.....	383
Vertical Stripping.....	384
Incomplete Layer Brace.....	385
Step-Up Brace.....	386
Bulk Load.....	387
V-Type Bulkhead.....	388
A-Type Ventilator.....	389
Top Ice or Ice Over Load.....	390 - 392

VIII

	<u>Paragraph Numbers</u>
Reporting Loading In Mixed Cars or Trucks	393
REPORTING RANGE AND AVERAGE PERCENTAGES	394-404
Averages	394-395
Ranges	396-398
Use of Fractions	399-401
Certifying Bulk Loads	402
When Small Number of Specimens in Package	403
Reporting Averages on Restricted Certificates	404
GENERAL QUANTITY TERMS	405-422
Complements of Most Quantity Terms Necessary	406-407
Uses of "Generally"	408-411
Uses of "Mostly"	412-414
Uses of "Remainder"	415
Uses of "Approximately", "About"	416-418
Large Proportion First	419
Entire Lot must be Accounted For	420
Do Not Omit Qualifying Terms	421
Reporting Fractional Percentages	422
PACK	423-449
Very Tight	427
Level Full	428
Tight or Well Filled	429
Fairly Tight or Fairly Well Filled	430
Slack	431
In Bulk or Sacks	432
Cell and Tray Packs	433
Bulge	434
How to Judge Tightness of Fill	435-436
Arrangement in Layers	437-441
Straight Pack	438
Diagonal Pack	439
Off-Set Pack	440
Bridge Pack	441
**** Reporting Gross or Net Weight of Containers	442-448c ****
**** Certifying Weights of Products in Bulk Bins	448c****
Pack a Factor of Condition	449

Paragraph
Numbers

SIZE.....	450 - 459
Range of Size.....	451
"Mostly".....	452
Reporting Undersize Within or Well Within Tolerance.....	453 - 456
Reporting Counts or Packs.....	457
Bunching.....	458
Standard Pack, Standard Bunching, etc.....	459
QUALITY AND CONDITION.....	460 - 521
Quality (defined).....	461
Condition.(defined).....	462
Grade and Standard (defined).....	463 - 464
Descriptive terms.....	465 - 477
Reporting Quality and Condition Factors Which Do Not Affect Grade.....	467
Color.....	468 - 472
Maturity.....	473
Distinction Between Mature and Ripe.....	474
Distinction Between Ground Color and Varietal Color...	475
Variation of Maturity or Color in Lot Should be Shown.	476
Policy in Describing Freshness and Firmness.....	477
Grade Defects.....	478 - 490
General Policy in Describing Defects and Irregular Conditions.....	485 - 490
Tolerances.....	491 - 502
Grade Tolerances.....	492
Container or Package Tolerances.....	493
One Defective Specimen Allowed in a Package.....	494
Reporting Defects Within Tolerance.....	495
Grade Defects Within Tolerance.....	496
Grade Defects Average Within Tolerance.....	497
Grade Defects Well Within Tolerance.....	498 - 499
Grade Defects Each Lot Within Tolerance.....	500
Reporting Defects Exceeding Tolerances.....	501
Reporting Defects on Percentage U.S. No. 1 Quality....	502
Counting Defective Specimens More Than Once.....	503 - 504
Reporting Defects of Commercial and Combination Grades..	505
Reporting the Higher Grade in Combination Grades.....	506
Dirt or Washed and Unwashed Root Products.....	507
Scoring Loose Dirt in Containers of Root Crops.....	508 - 510
Freezing Injury.....	511 - 513

	<u>Paragraph Numbers</u>
Decay.....	514 - 520
Reporting Soft Rot Separately.....	516
Reporting Percentages of Decay.....	517 - 519
Determining Percentages of Decay When Specimens are Excessively Deteriorated.....	520
Latent Defects.....	521
UDE.....	522 - 566
Supplemental Grade Statements.....	524
Grade on Restricted Certificates.....	525
When No Established Grade.....	526
Certification of Shipper's Brand Grades.....	527
Grade Statements Qualified as to Size.....	528
"Unless Otherwise Specified".....	529
No Size Limitation Specified in the Grade.....	530
Small, Medium, Large, Very Large, Extra Large.....	531 - 532
Size Marks Required on Containers by Standards.....	533
Special Grade Designations.....	534 - 537
Certifying Standard Pack, Standard Bunching, etc. in Grade Statement.....	538
Use of "As Marked".....	539
Certifying Combination or Commercial Grades.....	540 - 541
Reporting Lots that Are Out of Grade.....	542
Reporting Percentages of U. S. No. 1 Quality.....	543 - 544
Reporting Grade in Approximate Percentages.....	545 - 548
Grades With "Unless Otherwise Specified" Clauses.....	549
When Percentage of U.S. No. 1 Quality Below 50%.....	550
Container Tolerances Do Not Limit Percentage of U.S. No. 1.....	551
High Percentages of U. S. No. 1 Quality.....	552
Serious Defects of a Progressive Nature Must be Reported in Connection With Grade Statements on Percentage Lots.....	553 - 555
Reporting Percentages of U. S. No. 2 Quality.....	556
Reporting Percentages of U. S. Fancy Grade.....	557
Instructions for Reporting U. S. Fancy and U. S. No. 2 Quality.....	558
Certifying Percentage of Grade A Quality on Consumer Grades.....	559
Determining Weighted Averages of U. S. No. 1 or Other Grade Quality.....	560 - 561
Reporting Overgrade Stock in a Lot.....	562 - 565
When a Lot Meets a Higher Grade Than Marked.....	566

Paragraph
Numbers

REMARKS..... 567 - 573

RESTRICTED CERTIFICATES..... 574 - 586

 Examples..... 579

 Last of Loading Not Inspected..... 580 - 581

 Restricting Certificate to Certain Marks, Varieties or
 Grades..... 582 - 583

 Restricting Certificate to One Point..... 584 - 586

CONTINUOUS INSPECTION..... 587

VISUAL AIDS..... 588

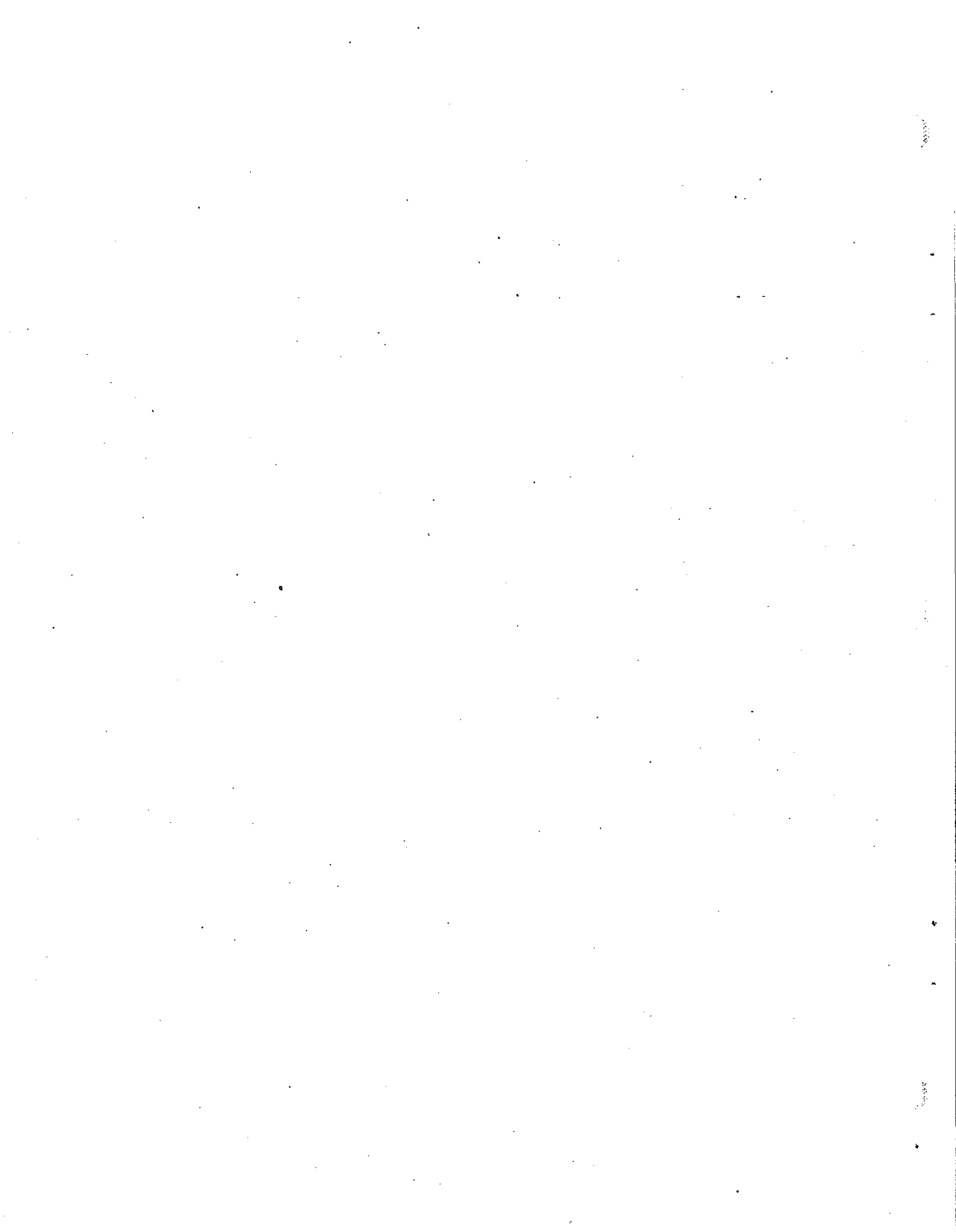

UNITED STATES DEPARTMENT OF AGRICULTURE
AGRICULTURAL MARKETING SERVICE
FRUIT AND VEGETABLE DIVISION
FRESH PRODUCTS BRANCH

GENERAL INSPECTION INSTRUCTIONS
SHIPPING POINT 1/

PART I

INTRODUCTION

These instructions are a general guide for shipping point inspectors. They contain the basic principles on which certification is made on more than 80 products which are inspected annually by the Service somewhere in the States and Puerto Rico. Additional inspection instructions applying to specific commodities have been issued for the more common products. The Federal Supervisor in charge of the work in each area will issue the necessary instructions covering others. All such instructions will be based on the principles laid down in these General Instructions. It is, therefore, highly important that they be studied carefully by each inspector and scrupulously followed. When the inspector is in doubt regarding the course to be followed under any unusual circumstances, he should consult his supervisor. (1)

FUNDAMENTAL PRINCIPLES OF INSPECTION

In every inspection it is absolutely essential that all pertinent facts be determined and stated as accurately as possible. No circumstances can be permitted to influence the accuracy of this work. (2)

It can make no difference to the inspector, in the conduct of his work, who may be the grower, shipper or buyer of the product on which he is working; or for whom the inspection is being made. It is none of his concern whether the supply may be generally poor and light with demand active and prices high, or heavy supplies of good stock available with poor demand and low prices. If a lot of any product is represented as either better or worse than it really is, some one may be injured and our service will suffer in value and prestige. It is necessary to remember at all times that our certificates have no place for opinions or comparisons; they are intended solely for statements of known facts. It is up to each man to be familiar with the instructions pertaining to his work and to see that he follows them. This is his personal responsibility for which he will be held strictly accountable. (3)

1/ These Instructions supersede "Shipping Point Handbook" revised August, 1959.

- (4) Inspections made for Government agencies on price support, export and subsidy programs and truck shipments, must receive the same care that is accorded commercial carlot shipments.

AUTHORITY FOR THE INSPECTION SERVICE

- (5) The Fresh Fruit and Vegetable Inspection Service was started in 1917. Until 1922 its authority was restricted to work in destination markets where the inspections were made by Federal Market Inspectors. In 1922 Congress extended the service to shipping points by adding to the appropriation authority the words, "when offered for interstate shipment." From the beginning of the service, it has been partially supported by appropriations made annually in the Agricultural Appropriation Act. Since 1946 financial aid has also been given annually by appropriations under the Agricultural Marketing Act, which gives the authority for our inspection activities. Under this authority the Secretary of Agriculture has issued S.R.A. - A.M.S. No. 93, Revised, Rules and Regulations of the Secretary of Agriculture Covering the Inspection and Certification of Fruits and Vegetables and other Products. Each inspector may obtain a copy of these regulations from their Federal Supervisor.

When the work was extended to shipping points, no additional funds were provided by Congress for the expanded service requested by the industry. As it was held that the Federal Department, working independently, could not collect fees and use them to pay the cost of the service, a plan was developed under which the inspection work at shipping point could be done under cooperative agreements with the States. These agreements provide that the inspectors are to be employed by the States and licensed by the Federal Department. The State collects the fees and from them pays the inspectors' salaries and other expenses of operating the service. The Federal Department supervises the inspection and certification work for which it is reimbursed by the State. The State also pays the Federal Department a small charge for Federal overhead.

- (7) In recent years a few cooperative agreements have been entered into under which the Federal Department employs the inspectors who issue Federal certificates. The fees are collected by the Federal Department and are held by the Federal Treasurer in a Master Trust Fund Account from which the expenses of the work are paid.
- (8) Receiving Market inspectors issue straight Federal certificates and the fees collected also go into a Master Trust Fund Account. When shipping point inspectors issue cooperative Federal-State certificates, the fees collected go into a fund maintained by the various states.

The inspector is frequently confronted with some new condition or practice with which they are not familiar but which may be a matter of common knowledge to growers and others in the community. The inspector should not publicly express his or her ignorance of such practices, but by judicious questioning and observation obtain the desired information. Uncertainty as to grade factors and indecision are always looked upon by patrons of the Service as evidence of carelessness. The inspector must strike a happy medium between these extremes. (28)

The inspector must not assume responsibility for packing house operation. The inspector should always be ready to give information regarding grade and pack, but must never allow themselves to be held responsible. An understanding should be had with the management and the foremen at the beginning of the work as to the limit of the inspector's responsibility in this connection. An understanding should also be reached as to the person to whom the inspector is to report the results of their examinations both during the progress of the inspection and after it has been completed. Usually the packing house foreman is the proper party to whom a report should be made of the failure of samples to meet the specifications of the designated grade. (29)

Before inspection is started, a definite understanding should be reached with the manager as to whether the inspector is to certify the output as it comes from the packers or whether a certain grade is to be made and the inspector is expected to give notice when the tolerance is being exceeded. Prompt action is necessary in the latter case for the foreman is looking to the inspector for prompt advice as to failure of the graders and packers to turn out the required grade. (30)

The inspector must not criticize one member of the industry before another. They're hired to inspect and certify the quality and condition of products - not to express opinions about business practices. (31)

The inspector may learn much about the business of certain shippers. Such information should be treated as confidential and under no circumstances is it to be given to a competitor or others outside of the Service. (32)

The inspector should not make critical remarks to the trade or others in connection with work assignments, inspection or service policy or other matters concerning only the inspection service. In some areas shipping point inspectors, through long associations with individual shippers, sometimes develop especially friendly relationships with applicants. In these instances the inspector should exercise special care not to criticize official instructions or policies to them and not to disclose to them confidential information. Failure to do so may make it necessary for the supervisor to transfer the inspector to another inspection station. (33)

- (34) Relation of the Inspector with Other Inspectors. The inspector should avoid arguments with other inspectors in the presence of outsiders regarding grade interpretations or other matters relative to the Service. Such differences of opinion should be confined to private discussion and usually should be referred to the Supervising Inspector.
- (35) It is unethical to criticize other inspectors in the presence of those outside the Service and criticism of other inspectors by outsiders should be discouraged. This includes inspectors in other areas or states as well as those with whom the inspector works. The inspector should inform those who complain of another inspector's work that they should take the matter up with the Supervisor.
- (36) New inspectors, and men working on commodities with which they are not very familiar, should be given all possible information and assistance, not only by the Inspector in Charge, but by all experienced men working in the district. Advice or instructions should not be withheld from a man when it is noticed that he is not following proper procedure in his inspection work or his contact with the public. On the other hand, the new inspector or the inspector who is inexperienced in a commodity, should not resent having information or advice offered by an experienced inspector who is not his supervisor. He should heed the instructions or advice and have his supervisor verify it at the earliest opportunity if he desires.

RULES OF CONDUCT FOR INSPECTORS

- (37) Honesty and impartiality are the foundation stones of the Inspection Service. Inspectors must conduct themselves at all times in a way that will not bring discredit or disrespect to themselves or to the Service. Their integrity must be above question. Any serious or repeated misconduct will be cause for suspending or revoking an inspector's license. While the list is not exclusive, the following forms of misconduct are cause for disciplinary action:
1. Inspectors must not use alcoholic beverages in any form while on the job. Their use off the job must not bring discredit to the inspector or to the Service and must not interfere with the performance of official duties.
 2. Inspectors must not borrow money or accept other financial favors from shippers, growers or other users of the Service.
 3. Inspectors must not accept offers of aid in getting trade-in allowances, unusual discounts, etc. Acceptance of such favors places the inspector under obligation to the giver.

The cooperative agreements under which the shipping point service (9) is administered are not always with State departments of Agriculture, although that is generally the case. Some agreements are with the Extension Service and one is with a State Cattlemen's Association. As a matter of convenience, the words "State" or "State Department of Agriculture" will be used in this Handbook to refer to the agency which cooperates with the Federal Department in this service, regardless of the nature of its organization.

RELATIONSHIP OF THE INSPECTOR

Relation of the Inspector to the State. When the shipping point (10) inspector is employed by the State he receives his pay from the State. Terms of employment, methods of payment of salaries, salary rates and personnel requirements are different in the various states. The inspector should reach a definite understanding with the State regarding the terms and conditions of his employment. State officials are furnished, by the Federal Department, a list of available inspectors with a record of their past performances. It should be distinctly understood that the Federal Department does not usually employ the shipping point inspectors but issues Federal licenses to those who are believed to be competent to properly certify the quality and condition of the commodity on which the inspector is to work.

In a few states the inspectors also act as regulatory officials in (11) the enforcement of state standardization, inspection or quarantine laws. Inspectors under such circumstances, and the states that employ them, must clearly distinguish between their duties as Federal licensees and State regulatory officials and should make clear to all parties concerned that the Federal Department is in no way responsible for their regulatory activities. Any attempt to use the Federal license card as evidence of authority to force a shipper to any course of action under a state regulation may result in cancellation of the license.

* Relation of the Inspector to the Federal Department. Each coopera- (12) *
 * tive agreement provides that the Federal Department will be represented *
 * by a Federal Supervisor to work with the State in conducting the Service. *
 * It is his duty to issue Federal license cards to inspectors employed by *
 * the State if he believes them to be competent to properly certify the *
 * quality, condition and grade of the commodities to be inspected. Certifi- *
 * cates signed by a properly licensed shipping point inspector have the same *
 * weight as other Federal certificates. *

- (13) The Federal Supervisor is responsible for training and the supervision of the licensees in grade interpretations, inspection procedure, certificate writing and relationships with the trade. The Federal Department, through its Federal Supervisors, is responsible for issuing certificates that are based on uniform grade interpretations and written in descriptive terms that are of uniform definition at all shipping and receiving points throughout the country so that shippers and receivers will have accurate, reliable documents of uniform interpretation on which to trade.
- (14) Licensee's Personnel Record Cards. The obligations of the licensee to the Federal Department are set forth on the back of the Licensee's Personnel Record Card which each inspector is required to sign in quadruplicate at the time he is first licensed. One copy goes to the files in Washington, one to the files of the Federal Supervisor, one to the District Supervisor and one copy should be retained by the licensee.
- (15) When the licensee signs this card, he agrees to abide by Federal instructions governing the shipping point inspection of fruits and vegetables whether they are given to him personally by the Federal Supervisor or in the form of handbooks, memoranda or other written instructions. He also agrees to accept the interpretations of the Federal Supervisor or other representative of the U. S. Department of Agriculture. He agrees to make clear and accurate inspection notes of each inspection and to write certificates from such notes strictly in accordance with Federal instructions. Lastly, he agrees to surrender his license card to his Federal Supervisor on request or at the end of any inspection deal, or by June 30 following the date on which it was issued.
- (15) Federal License Cards. The Federal license card authorizes the inspector to issue Federal-State certificates on the products indicated on the back of the card. Inspectors are not permitted to sign certificates until they have been issued valid license cards countersigned by the Federal Supervisor. License cards should not be back dated to cover certificates already issued.
- (17) Correct first names or initials of inspectors should appear on license cards, and not nicknames. The name on the license card should be exactly the same as that on back of the personnel Record Card and the signature used in signing certificates.

When an inspector becomes qualified to certify a commodity, the Federal Supervisor will list it on the back of his license card. State Supervisors or other supervisors are not permitted to add commodities to an inspector's license card. Only the Federal Supervisor does this. (18)

Federal license cards may be carried from one state to another and used without the signature of the Federal Supervisor in the new state but should always be presented to him for his examination and listing before actual inspection work is begun. It will be sufficient for the Federal Supervisor to whom the licensee has reported from a previous assignment in another state to initial the licensee's card which he received on the previous assignment. The date on which the card is initialed should also be shown together with the name of any additional commodities which the licensee is being authorized to certify. (19)

Licensees must surrender their license cards to the Federal Supervisor at the completion of their employment in his area of supervision, however, supervisors need not require licensees to surrender their cards upon leaving their jurisdiction when it is known that they will continue to inspect under other supervisors within a reasonable time within the fiscal year. (20)

License cards expire June 30 each year and new ones must be issued before any certificates may be signed by the inspector in the new fiscal year. All cards are to be turned in on June 30 to the supervisor under whom the licensee is working at that time, or last worked, or are to be mailed to the Fruit and Vegetable Division of the U. S. Department of Agriculture, Washington, D. C. All expired license cards are filed in the Washington office so that it can be determined what products the licensee was authorized to inspect in any given year. (21)

If the licensee continues to work beyond June 30, the Federal Supervisor will issue him a new card listing on its back the names of all commodities appearing on the expiring card. In listing the commodities which the licensee has been authorized to inspect, the supervisor will not restrict the commodity to any particular state. Once an inspector has qualified to certify a commodity in one state, the same authority holds in all states. (22)

The license cards of "key men" or supervising inspectors who have immediate supervision over certain groups of inspectors, must, in addition to the signature of the Federal Supervisor, bear the initials of a representative of the Fruit and Vegetable Division in Washington. When issuing cards to these men, the Federal Supervisor will write or type across the top of the face of the card the words "For Supervisory Work" and forward it to the District Supervisor who will review it and forward it to the Washington office for approval. (23)

- (24) Suspension or Revocation of License of Licensed Inspector is the heading of Section 51.34 of Service and Regulatory Announcements No. 93, Revised, which provides that, any license may be suspended by the Administrator of C&S, pending final action by the Secretary whenever such official shall deem (on the advice of the Chief of the Branch and the Federal Supervisor) such action is necessary. Within 7 days after the receipt of the notice, and statements of reasons, by such licensee, he may file an appeal in writing with the Secretary supported by any argument of evidence that he may wish to offer as to why his license should not be suspended or revoked.
- (25) Inspectors Have no Regulatory Authority. All inspectors should keep in mind at all times that under their Federal authority, they have no regulatory or police powers. Their Federal authority is to render a service to the fresh fruit and vegetable industry in certifying the quality and condition of products which they are requested to inspect. The Federal Department enforces the Export Apple and Pear Act and the Export Grape and Plum Act. A licensed inspector's duty in this connection is to issue the Export Form Certificate when his inspection shows that a shipment meets the requirements of the Act. The Federal Department also enforces the Perishable Agricultural Commodities Act. The inspector should follow instructions in paragraphs 119-118 regarding reporting misbranding.
- (26) Relation of the Inspector to the Trade. Honesty and impartiality are foundation stones of the Service and all inspectors should avoid any conduct which might raise a question in the minds of patrons as to their observance of these principles. The inspector is warned against accepting favors from any one in the industry. Such favors may be offered in many forms such as Christmas presents, high priced dinners, tickets to football games or other entertainments, gifts of money or other valuables for "specially efficient and accommodating service requiring a lot of over-time." Such favors must be respectfully declined for they imply that some favor has been granted by the inspector or may be expected in the future by the giver. The acceptance of such favors may result in the inspector being charged with "accepting a bribe" and as a matter of self-defense he should immediately report such offers to his supervisor.
- (27) The inspector should maintain cordial relations with all patrons of the Service and their employees but without becoming so friendly as to create an appearance of favoritism. Undue friendship between the inspector and a member of the trade should be avoided for it makes it difficult for the inspector to maintain an attitude of strict impartiality and may subject the Service to criticism. Even though no partiality is shown, competitors may suspect and accuse the inspector of being partial. Avoid frequent social contacts such as having dinner or attending shows with members of the trade. In no instance shall an inspector become involved in gambling games, such as poker, with members of the trade.

The inspector is frequently confronted with some new condition or practice with which they are not familiar but which may be a matter of common knowledge to growers and others in the community. The inspector should not publicly express his or her ignorance of such practices, but by judicious questioning and observation obtain the desired information. Uncertainty as to grade factors and indecision are always looked upon by patrons of the Service as evidence of carelessness. The inspector must strike a happy medium between these extremes. (28)

The inspector must not assume responsibility for packing house operation. The inspector should always be ready to give information regarding grade and pack, but must never allow themselves to be held responsible. An understanding should be had with the management and the foremen at the beginning of the work as to the limit of the inspector's responsibility in this connection. An understanding should also be reached as to the person to whom the inspector is to report the results of their examinations both during the progress of the inspection and after it has been completed. Usually the packing house foreman is the proper party to whom a report should be made of the failure of samples to meet the specifications of the designated grade. (29)

Before inspection is started, a definite understanding should be reached with the manager as to whether the inspector is to certify the output as it comes from the packers or whether a certain grade is to be made and the inspector is expected to give notice when the tolerance is being exceeded. Prompt action is necessary in the latter case for the foreman is looking to the inspector for prompt advice as to failure of the graders and packers to turn out the required grade. (30)

The inspector must not criticize one member of the industry before another. They're hired to inspect and certify the quality and condition of products - not to express opinions about business practices. (31)

The inspector may learn much about the business of certain shippers. Such information should be treated as confidential and under no circumstances is it to be given to a competitor or others outside of the Service. (32)

The inspector should not make critical remarks to the trade or others in connection with work assignments, inspection or service policy or other matters concerning only the inspection service. In some areas shipping point inspectors, through long associations with individual shippers, sometimes develop especially friendly relationships with applicants. In these instances the inspector should exercise special care not to criticize official instructions or policies to them and not to disclose to them confidential information. Failure to do so may make it necessary for the supervisor to transfer the inspector to another inspection station. (33)

- (34) Relation of the Inspector with Other Inspectors. The inspector should avoid arguments with other inspectors in the presence of outsiders regarding grade interpretations or other matters relative to the Service. Such differences of opinion should be confined to private discussion and usually should be referred to the Supervising Inspector.
- (35) It is unethical to criticize other inspectors in the presence of those outside the Service and criticism of other inspectors by outsiders should be discouraged. This includes inspectors in other areas or states as well as those with whom the inspector works. The inspector should inform those who complain of another inspector's work that they should take the matter up with the Supervisor.
- (36) New inspectors, and men working on commodities with which they are not very familiar, should be given all possible information and assistance, not only by the Inspector in Charge, but by all experienced men working in the district. Advice or instructions should not be withheld from a man when it is noticed that he is not following proper procedure in his inspection work or his contact with the public. On the other hand, the new inspector or the inspector who is inexperienced in a commodity, should not resent having information or advice offered by an experienced inspector who is not his supervisor. He should heed the instructions or advice and have his supervisor verify it at the earliest opportunity if he desires.

RULES OF CONDUCT FOR INSPECTORS

- (37) Honesty and impartiality are the foundation stones of the Inspection Service. Inspectors must conduct themselves at all times in a way that will not bring discredit or disrespect to themselves or to the Service. Their integrity must be above question. Any serious or repeated misconduct will be cause for suspending or revoking an inspector's license. While the list is not exclusive, the following forms of misconduct are cause for disciplinary action:
1. Inspectors must not use alcoholic beverages in any form while on the job. Their use off the job must not bring discredit to the inspector or to the Service and must not interfere with the performance of official duties.
 2. Inspectors must not borrow money or accept other financial favors from shippers, growers or other users of the Service.
 3. Inspectors must not accept offers of aid in getting trade-in allowances, unusual discounts, etc. Acceptance of such favors places the inspector under obligation to the giver.

4. Inspectors must not accept gratuities or gifts from patrons of the Service. This includes Christmas presents, high priced dinners, tickets to ball games, etc.
5. Money, other valuables or gifts must not be accepted for "especially efficient or accommodating service requiring a lot of overtime." Such acceptance may be construed as "accepting a bribe."
6. Inspectors must have no financial interest, directly or indirectly, in the products they inspect.
7. Inspectors may take no active part in political management or political campaigns.
8. Severe penalties will be imposed for knowingly falsifying government documents including expense vouchers, field notes and certificates.
9. Inspectors may not be members of a political party that advocates overthrow of our government by unconstitutional means.
10. Inspectors may not accept a bribe. Offers of bribes should be reported to the federal supervisor immediately, for the inspector's protection. Investigation of bribery charges are made by the FBI; other investigations may be made by the Regional Inspector General - USDA.

Borrowers. Inspectors are forbidden to borrow money or accept other (38) financial favors from growers, shippers or other patrons of the Service. Offers of aid in getting trade-in allowances, unusual discounts on purchases or repairs or other services (including room rents) should be politely declined as they are often made with the purpose of placing the inspector under an obligation. The inspector should have no obligation to those for whom he makes inspections except to properly certify the product offered. It has been necessary to refuse to renew the licenses of a number of inspectors who violated this rule. Failure to meet obligations for board and room, services, automobile repairs, etc. casts a reflection on the integrity of the licensee and may raise a question as to his dependability as an inspector.

(39) Financial Interest of Inspectors. 7 CFR, Part 51, Section 51.15 reads: "No inspector shall inspect any products in which he is financially interested, either directly or indirectly." Direct interest includes ownership of, or agency control over, the product. Indirect interest includes business relations with the owner of the product such as employee, partner or agent and any personal relationship with the owner, foreman, grader or other employee which may raise a question as to the impartiality of the inspector.

(40) Discreet Speech. An inspector frequently gets into trouble for talking too much, but seldom for talking too little. Avoid careless remarks to bystanders about the quality of the product which is being inspected. Such remarks may be used by buyers to "beat down" the price of the commodity. Do not make comparisons of the qualities of products produced by different growers or grown in different sections. Local growers and shippers do not like to hear their products compared unfavorably with those of another area, state, or competitor.

(41) Observance of "No Smoking" Rules. Some shipping firms have rules against smoking in their buildings. Such rules are because of the fire hazard and the possibility of higher insurance rates if smoking is permitted. All inspectors while on an applicant's premises should respect and observe the same restrictions relative to smoking that the management imposes on its personnel.

(42) Political Activity. All inspectors are forbidden, during the period of their respective appointments or licenses, to take an active part in political management or in political campaigns. Political activities in city, county, state or national elections, whether primary or regular, or in behalf of any party, candidate or measure to be voted upon, are prohibited. This applies to all appointees or licensees. Wilful violations of this section will constitute grounds for revocation of licenses in the case of licensees. (Refer to Section 51.47, 7 CFR, Part 51).

* (42a) Reporting Alleged or Suspected Bribery. AMS Instruction 366-1 on *
Reporting Misconduct and other offenses, was revised November 22, 1972. *
* Paragraph V of these Instructions deals with reporting alleged or *
suspected bribery and applies to all shipping point inspectors. Para- *
* graph V states that "Any employee or Federal licensee who is offered a *
bribe or who believes that a bribe was offered, solicited, or accepted *
* by another employee shall:

<u>REGION NO.</u>	<u>ADDRESS</u>	<u>TERRITORY</u>
* 4	Regional Director	Illinois, Indiana, Michigan
*	Office of Investigation, USDA	Minnesota, Ohio, Wisconsin
*	1 North Wacker Drive, Room 800	
*	Chicago, IL 60606	
*	Telephone (312) 353-1358	
* 5	Regional Director	Arkansas, Louisiana, New Mexico
*	Office of Investigation, USDA	Oklahoma, Texas
*	3912 South General Bruce Drive	
*	Temple, TX 76501	
*	Telephone FTS (817) 773-1351	
*	(817) 773-1711	
*	Ext. 351	
* 6	Regional Director	Iowa, Kansas, Missouri,
*	Office of Investigation, USDA	Nebraska
*	Post Office Box 205	
*	Kansas City, MO 64141	
*	Telephone (816) 926-6611	
* 7	Regional Director	Alaska, Arizona, California,
*	Office of Investigation, USDA	Colorado, Hawaii, Idaho, Montana,
*	555 Battery Street, Room 522	Nevada, North Dakota, Oregon,
*	San Francisco, CA 94111	South Dakota, Territory of Guam,
*	Telephone (415) 556-6443	Trust Territories of the Pacific,
		Utah, Washington, Wyoming

GENERAL INSTRUCTIONS

(43) Refusing to inspect. An inspector in charge of an office may refuse to inspect if -

1. The applicant objects to the inspector cutting an adequate number of specimens to determine the interior quality or condition;
2. The applicant fails to furnish necessary information or to make the commodity reasonably available or accessible for inspection;
3. The applicant refuses to pay for previous inspections;

4. In case of fraud or misrepresentation;
5. The applicant interferes with an inspector; or
6. When it appears that to perform the inspection would not be to the best interests of the Government. (See Sections 51.10, 51.52 and 51.54 of Regulations S.R.A. No. 93, Revised).

Before refusing service to an applicant, a definite procedure must be followed by the Chief of the Branch. In the absence of a marketing agreement, and in emergencies that require immediate action, it may be possible to deny inspection for a short period, but an opportunity for a hearing must be given an applicant before permanent debarment of the service can be made effective. Should any of the above situations arise, the inspector should see that his Federal Supervisor is advised who will be guided by the detailed instructions in the Manual for Shipping Point Supervisors, page 23. (44)

Prima Facie Evidence. The Perishable Agricultural Commodities Act provides that certificates issued by the authorized agents of the United States Department of Agriculture shall be received in all Federal Courts as prima facie evidence of the truth of the statements therein contained. Such certificates are also prima facie evidence in proceedings in the courts of many states. The term "prima facie evidence" as thus used, means that such evidence will be sufficient for the proof of the facts unless contradicted and overcome by superior evidence. (45)

When inspecting raw products for processing on a processor's contract specifications, or on a U. S. Standard for processed products that permits variations in specifications, the inspector should obtain a copy of the contract or a written copy of the specifications in other form. This he will secure from his Federal Supervisor or from the contractor with the approval of the Federal supervisor. In such specifications all terms, such as "damage by—," etc. should be clearly defined for each factor or defect. The inspector should become thoroughly familiar with all contract specifications before he starts grading. (46)

If the processor plans to deviate from these specifications, he must notify the inspector's Federal Supervisor and secure his approval before inspections can be made on such deviations. The inspector should always remember that he takes his instructions in connection with grade interpretations and inspection procedure from his supervisor, not from processor or the grower. (47)

- (48) Attempting Too Many Inspections. The inspector must not attempt to certify more lots than can be properly examined. He should get in touch with his supervisor immediately when he has more work than he can properly handle.
- (49) Order of Inspections. Applicants who have made blanket inspection requests are entitled to priority over those who make applications from day to day. If inspections are made "on call," they should be handled as nearly as possible in the order of receipt. Occasional variations may be made from this policy when it is possible to handle more applications by so doing.
- (50) When a shipper is depending on the Service to inspect certain lots or his entire output, it is very embarrassing if some of them are missed because of lack of time. Shippers should be informed that they should file their applications far enough in advance to enable the Service to properly adjust its personnel. It is manifestly unfair for a shipper who has been applying for inspection of only one car a day to apply for 10 cars without any advance notice. Regular applicants should be given preference until sufficient help has been furnished by the Supervisor to take care of such unexpected demands for service.
- (51) Responsibility for Condition of Load. It is the duty of the applicant to make the product accessible for inspection but in practice it is often necessary for the inspector to disarrange part of a loaded car or a lot without the knowledge of the applicant. If he does this he is responsible for replacing the packages as he found them. If the load has been made accessible by the shipper it is not the duty of the inspector to restore it to its original condition except for closing packages. The inspector should always carry a sack needle, nails, and any other tools or material necessary for this purpose. The inspector should guard against unnecessarily breaking or splintering boxes or damaging other containers. Each package of produce an inspector opens is the property of some one and is entitled to the same care which thoughtful persons generally show to the property of others.
- (52) Breaking Seals and Resealing Cars. The Federal authority under which a licensed fruit and vegetable inspector works does not permit him to break car seals. A Federal statute imposes heavy penalties for unlawful breaking of seals on cars containing shipments moving in interstate commerce. Care must be taken by the inspector that he does not lay himself open to the technical charge of violating this statute. When it is necessary to enter a sealed car in connection with official business, permission must be first obtained from the local railroad agent or yardmaster. The inspector should also comply strictly with any instructions given him by the agent relative to resealing the car and reporting to him the number of the seal broken, etc.

- 13 -

Cars of produce originating in Canada or Mexico and moving through (53) the United States to another country are sealed with custom seals. These seals are usually distinguishable from railroad company seals by red or blue paint on the ball of the seal. They are embossed "U.S.C. in Bond" and also carry the port name and seal number. Federal statutes provide a penalty of two years imprisonment or a fine of \$5,000.00, or both, for the breaking of a customs seal by one other than a customs officer.

Precaution Against Injury. When pulling out ice plugs, never (54) stand near the edge of the roof of the car. If a plug sticks, do not run the risk of a back sprain by trying to pull it out by unaided muscular strength; use a lever or bar or get other assistance if necessary.

Use Caution in entering a car which may have been heated or gassed (55) with fumigant and kept closed. Burning charcoal is especially dangerous because of the quantity of carbon monoxide gas which it produces. If an inspection must be made in a car which has been heated, it should be thoroughly aired before entering.

When entering a packing house, it is always advisable to use the (56) steps provided for that purpose. Be careful of your steps on wet floors; avoid low, overhanging racks and do not vault over moving belts. When entering a car, be sure the runway is properly secured and watch out for low doorways. Keep out of the path of truckers and fast moving lift trucks.

Inspectors employed by the States and licensed by the Federal De- (57) partment are not entitled to Federal aid under the United States Employee Compensation Act. Some States provide for medical aid and compensation to employees injured during the performance of duty. In cases of injury inquiry in this connection should be made of the State Supervisor.

* State Serial Lot Numbers. The Shipping Point Inspection Service in (58) *
 * many States has adopted a State identified serial lot numbering or coded *
 * date numbering stamp to be applied to individual containers at time of *
 * inspection. Its use provides identification between the lot or day's *
 * pack being inspected and the certificate issued describing it. *

* The inspector certifying lots identified by such stamps is respon- (58a) *
 * sible for the proper use of the stamp at all times. He and his supervisor *
 * must assure themselves that containers so stamped are identifiable for *
 * proper certification. Failure to do so could result in improper or *
 * unrelated certification or misuse of such stamps by their being applied *
 * to containers of uninspected produce. *

(59) State serial lot stamps are of numerous types but the identification on them consists basically of the name of the state, a permanent stamp number and three interchangeable numbers that will indicate 000 to 999 consecutively. The number should be changed for each lot certified. An adequate record is necessary for each stamp showing the date and where used, the inspector, the applicant, etc. Care must be exercised not to use the same number more than once in one crop year.

(60) Certificates issued in connection with Marketing Orders or Agreements shall show compliance or non-compliance with the terms of the applicable Order or Agreement. Such certificates may not be restricted to a portion of the lot but must cover the entire lot.

Upon request for inspection by the shipper, a complete size, quality, condition and grade inspection will be made and reported on the certificate. If a Marketing Order or Agreement requires certification as to only certain factors, such as size or pack, the shipper may elect to request an inspection and certification limited to these factors. For instance, a Marketing Order may require only a minimum size. In such cases, if a shipper requests certification as to size only, inspection is made for this one factor. The certificate would then be restricted to size only and show compliance or non-compliance with the Marketing Order. This does not relieve the requirement for unrestricted access to the lot or load for inspection purposes.

(61) Inspection Billed to Federal Agencies. Inspections made for, and billed to, Federal Agencies such as supplies for hospitals, military bases and stocks in storage for the DPSC or other agencies should be charged on an hourly basis. Collections of such charges are to be made by a transfer of funds between agencies in Washington. They should never be billed to the local activity.

*(62) Who is entitled to Information from Score Sheets. It is necessary to *
 * refuse request for copies of inspectors' notes or information from such *
 * notes from those who do not have a financial interest in the lot covered *
 * by such notes, unless the applicant instructs the inspector to give infor- *
 * mation from his notes to a prospective buyer. After the certificate is *
 * issued any important information from the notes can be furnished by letter *
 * upon request from a financially interested party holding or buying a copy *
 * of the certificate. A copy of the notesheet may be supplied to the *
 * applicant upon specific request and only with the approval of the Federal *
 * Supervisor. Others requesting a copy or information from the notes should *
 * be advised that it can only be obtained by court order in case the notes *
 * are subpoenaed (See paragraph 223). *

(63) Control of Copies of Market Certificates. Copies of federal market certificates are available to federal supervisors and their immediate staffs. Instances sometimes occur where the contents of these certificates are discussed with inspectors or supervisors in the field. Such information is confidential to the Inspection Service. If the shipper wants information from market certificates in connection with his shipments, he should request it from the market inspection office of origin and pay the usual fee charged for certificate copies.

Correspondence Relative to Inspection. Insofar as possible, all (64)
inquiries from the public concerning inspections that require a written
reply should be answered by the inspector in charge of the office where
they are received, with a copy to the Federal Supervisor. When the
inquiry involves the general policies of the Service, the local inspec-
tor should refer the matter to the Federal Supervisor for signature.

Signing the Certificate. The original of all typed certificates (65)
must be signed with ink. Export Form certificates must have the
inspector's signature on all but the file copies. When requested by
the applicant or required by Government subsidy or purchase programs,
one or more copies, as requested, should be signed by the inspector in
addition to the original. In some states it has been found desirable
for the inspector to sign the original and fourth copy with a ball
point pen. This makes a carbon signature on all other copies when snap
out carbons are used. As the office copies bear a carbon signature,
they can be checked to reduce the possibility of unsigned originals
being issued to applicants.

Signature by Supervising Inspectors. A supervisor may sign the (66)
certificate for an inspector working under him only when it is imprac-
tical for the inspector to be present to sign for himself. When signing
for another inspector, the supervisor should check the typed certificate
carefully against the inspector's notes. Only a "key man" or supervisor
having "For Supervisory Work" endorsed on his card may sign as super-
vising inspector. In such cases the supervisor is authorized to sign
his name under or to the left of the typed name of the inspector. This
signature should generally be over the supervisor's typed name and the
words "Supervising Inspector." The supervisor's name and title must
appear on all copies, preferably typed, but where impractical, longhand
signature on all copies is permissible in lieu of the typed name. In
large offices where any of several supervisors may sign a certificate,
it is not essential to type the supervisor's name if his signature is
legible on all copies. Example:

<u>Joseph Doakes-Supervising Inspector</u>	<u>Richard Roe</u> <u>Inspector</u>
	or
	<u>Joseph Doakes-Supervising Inspector</u>

*
*
*
*
*
*
*

*
*
*
*
*
*
*

* (66a) All inspection certificates have statements similar to the following *
* "I, the undersigned, a duly authorized inspector of the United States *
* Department of Agriculture do hereby certify that on the date indicated *
* ~~I personally inspected the above described product and that the quality~~ *
* and/or condition pertaining to said product was as herein " *
*

* (66b) Whenever it is necessary for the supervisor to sign the certificate *
* all reference to the fact that "I personally inspected" must be *
* deleted by the supervisor. Simply draw a line through the unnecessary *
* words or phrases and initial as shown in above example. Make sure that *
* the statement reads correctly after the deletions are made. *

(67) The term "Supervising Inspector" is not an official title but is a designation of duties. Such terms as "Inspector-in-Charge" are not to be used in signing certificates in this connection.

(68) It is illegal to sign the name of another person to a Government document without power of attorney. It is also illegal to sign Government documents in the blank form before they are typed. This includes Federal-State certificates.

(69) Power of Attorney. One employee may sign the name of another under authority of a power of attorney of a prescribed form and under specified limitations. Except under very unusual circumstances, this plan has no advantage over signature by the Supervising Inspector and should practically never be used. When it is considered necessary consult the Federal Supervisor. The essential forms for authority for power of attorney should be secured from the Washington office. Whenever Power of Attorney is granted, the person signing the inspector's name must also sign his own name. Example: Richard Roe by Joseph Doakes (it is not necessary, in this case, to make the deletions noted in paragraphs 66a and 66b).

(70) Blank Certificates Not to be Given to the Public. Occasionally request are received from patrons of the Service for blank certificate forms to be used in the preparation of extra copies. The Federal Department does not permit giving to the public any certificate form, either numbered or unnumbered, in the blank state.

(71) Making False Use of Official Certificate, Marks or Other Identification. Alterations of certificates, that have been issued, by anyone outside the Service is a Federal offense. If the inspector learns of erasures or alterations made on certificates by applicants or others, he should notify his Federal Supervisor immediately.

(72) The following is quoted from the Agricultural Marketing Act of 1946 as amended:

"Whoever knowingly shall falsely make, issue, alter, forge or counterfeit any official certificate, memorandum, mark, or other identification, or device for making such mark or identification, with respect to inspection, class, grade, quality, size, quantity, or condition, issued or authorized under this section or knowingly cause or procure, or aid, assist in, or be a party to, such false making, issuing, altering, forging, or counterfeiting, or whoever knowingly shall possess without promptly notifying the Secretary of Agriculture or his representative, utter, publish, or use as true, or cause to be uttered, published, or used as true, any such falsely made, altered, forged, or counterfeited official certificate, memorandum, mark, identification, or device, or whoever, knowingly represents that an agricultural product has been officially inspected or graded (by an authorized inspector or grader) under the authority of this section when such commodity has in fact not been so graded or inspected shall be fined not more than \$1,000.00 or imprisoned not more than one year, or both." (See paragraphs 110-118)

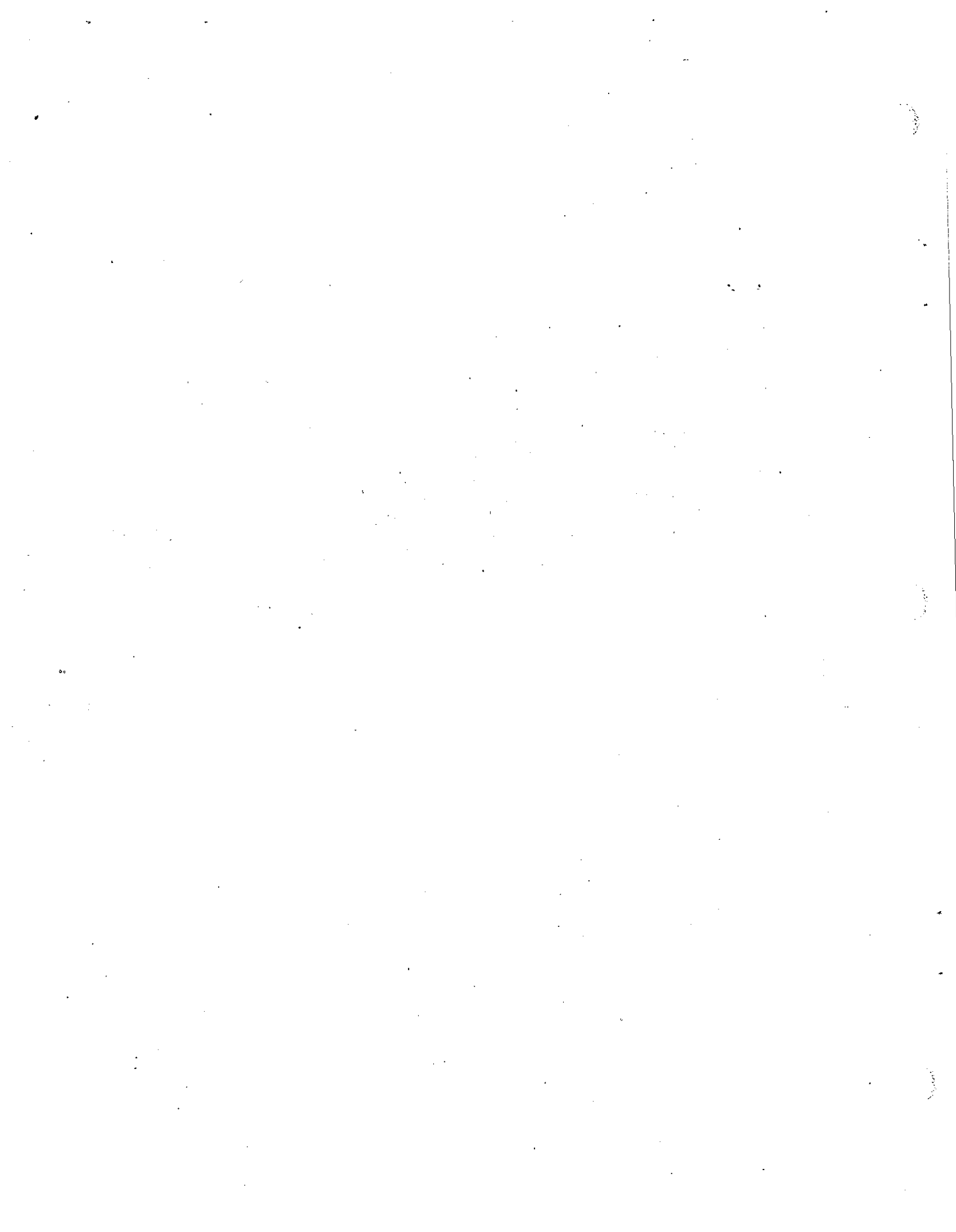

Identity Lost When Lot is Repacked or Reconditioned. When a lot of (73) produce covered by a certificate is reconditioned, a certain amount of the stock is removed. The lot ceases to be the same as originally certified, therefore, the certificate made prior to reconditioning no longer applies to the lot. If the applicant wishes a certificate to cover the reconditioned lot a new inspection must be made.

Issuing Two Certificates on the Same Car at Shipping Point. When (74) two or more certificates are issued on the same car at shipping point due to regrading or other reasons, reference to the certificate number and date of the first certificate should be made under a typed-in "Remarks" heading after the "Grade" heading near the bottom of the certificate. Unless later certificates are restricted to Condition Only or other factors, the Supervising Inspector should immediately notify the Washington office by collect telegram of the second inspection. Example: "Disregard certificate 11281 covering NP5684. Car re-graded and now covered by certificate 11355."

Marking of Cars. The inspector must print upon the inside wall of (75) every certified car near the door in such position as to be most conspicuous and legible, the state sign and the date of the certification, using blue or white crayon or chalk. This marking should occupy a space about 12 inches in length, or as near this as practical. Example:

CA-4-20-59

This means the carload was inspected in the State of California on April 20, 1959. It is very important to follow these instructions so that the inspector in the market will know that the car has been inspected at shipping point. If the walls are paper lined to the top, the marks may have to be placed on the ceiling. If the load extends above the top of the doorway, as is common with such products as spinach, the marks should be made near the tops of the insides of the doors. It is the policy in some states to mark the car over both doors on all cars inspected.

In some states car cards will also be used which are to be glued (76) or tacked in a conspicuous place upon the inside wall of the car as nearly above the marking as possible. Never erase the entries on a car card found in a car from a prior shipment and write in the date for the present shipment - use a new card. The use of the card does not take the place of crayon marking. The inspector may initial a card in one corner if he wishes. Enter the full date on a car card -- not just day and month. Old car cards should be removed or effaced as completely as possible.

(77) Table of State Abbreviations

Alabama	AL	Montana	MT
Alaska	AK	Nebraska	NB
Arizona	AZ	Nevada	NV
Arkansas	AR	New Hampshire	NH
California	CA	New Jersey	NJ
Colorado	CO	New Mexico	NM
Connecticut	CT	New York	NY
Delaware	DE	North Carolina	NC
District of Columbia	DC	North Dakota	ND
Florida	FL	Ohio	OH
Georgia	GA	Oklahoma	OK
Hawaii	HI	Oregon	OR
Idaho	ID	Pennsylvania	PA
Illinois	IL	Puerto Rico	PR
Indiana	IN	Rhode Island	RI
Iowa	IA	South Carolina	SC
Kansas	KS	South Dakota	SD
Kentucky	KY	Tennessee	TN
Louisiana	LA	Texas	TX
Maine	ME	Utah	UT
Maryland	MD	Vermont	VT
Massachusetts	MA	Virginia	VA
Michigan	MI	Virgin Islands	VI
Minnesota	MN	Washington	WA
Mississippi	MS	West Virginia	WV
Missouri	MO	Wisconsin	WI
		Wyoming	WY

(78) Inspection Service Car Seals. These will be furnished by the Washington office on request. They may be used whenever the inspector has reason to suspect that inspected products may be tampered with in the car during his absence, particularly when finished loads stand on the track during the night, or when it is impractical to reseal a car with railroad seals.

REINSPECTIONS IN THE MARKETS

(79) Condition and Confirmation Inspections. The great majority of lots that have been inspected at shipping point and are reinspected in the markets fall into this class. The most common reason a receiver or shipper wants a reinspection in the market is to determine the present condition of the product and secure a certificate showing any deterioration which may have developed since the first inspection. The market certificate may be restricted to reporting "condition only" or it may be a complete grade certificate covering all or a portion of the original lot. In the latter instance, if condition factors only are found to place the lot in excess of the grade tolerance, the grade statement will read: "Meets quality requirements but fails to grade U.S. No. 1 only account of condition."

The applicant sometimes requests an inspection in the market to confirm the original inspection by obtaining another inspector's statement to substantiate it or to secure an up-to-date certificate for sales purposes. This is called a "confirmation inspection." These are not considered appeal inspections. (80)

Appeal Inspections. The Rules and Regulations provide that an application for an appeal inspection may be filed by the original applicant or other financially interested party. If there is no question as to the identity of the lot and the applicant is acting in good faith and agrees to make the lot completely accessible for inspection an appeal inspection will be made when specifically requested. Appeal inspections are generally made in the markets, however, they may also be made at shipping point. (81)

It is the policy to have appeal inspection in destination markets made by two inspectors whenever practical. Under certain circumstances the Washington office will authorize reversal of an origin inspection by a single inspector. This will frequently be done when such factors as size, count, etc. are involved. All appeal inspections are made with more than ordinary care, double the usual number of samples being scored. Usually an appeal inspection is made only when the entire lot covered by the original inspection is available for examination. Occasionally an appeal will be made when a small part of the lot has been removed but a certificate will be reversed only when the defects in individual packages in the portion of the load remaining are so great that the car would be out of grade regardless of the quality of the remainder in the load. Lots will be reversed as to permanent factors only when the amounts of permanent defects are materially at variance with those reported by the shipping point inspector. Lots are reversed as to condition defects only when the time lapse since the original inspection is so small that there has been no chance for change. Such instances are very rare. (82)

If the shipping point certificate is reversed, no fee is charged the applicant although in some instances he may be billed for expenses involved. If the shipping point certificate is sustained, the applicant is charged the usual fee plus any expenses. Most requests for appeal inspections are received when it is found that a requested confirmation inspection does not meet grade on permanent factors and the applicant then requests an appeal. (83)

- (84) Appeal inspections will be made of truck shipments in the markets when the lot can be identified with reasonable certainty as being covered by the shipping point certificate. Truck shipments having original seals intact, or packages State lot stamped or in a truck that is a common carrier or other means of identification by SPI certificates, will be considered identification with "reasonable certainty."
- (85) Wiring at Request of Shippers. Inspectors at shipping points should not wire receiving market inspectors to make confirmation or appeal inspections at the request of the shipper. The destination market should receive the request direct from the shipper.

TELEGRAMS

- (86) Telegrams to the Washington office regarding technical matters or administrative policies should be sent "Collect." Wires giving reports of inspections requested by Washington or by inspection offices in the various markets should be sent prepaid.
- (87) Lengthy telegrams should be sent under the day-letter or night-letter rate as the time of day may demand unless the case is so important as to demand the faster service.

In preparing telegrams, unnecessary words should be omitted, but clarity should not be sacrificed for brevity. Ordinary punctuation marks such as commas, periods, and question marks are now transmitted without charge by the telegraph company. Punctuation should be inserted where necessary. It is no longer necessary to use the paid-for words: COMMA, PERIOD, STOP, etc. Up to five numerical digits as 98314, are transmitted for the rate of one word. Therefore, do not spell out car or certificate numbers as NINE EIGHT THREE FOURTEEN.. Decimal points count the same as figures, for example: 98.25 is counted as a word. FGEX counts as one word. 2-7/8 is counted as one word but 2 7/8 is counted as two words.

- (89) In addressing wires to market inspection offices, include the building or street number. These addresses are obtained from the address lists for the U.S. Fresh Products Inspection Branch, which are furnished by the Federal Supervisor's office from time to time.
- (90) A copy of an official telegram to either the Fruit and Vegetable Division, U.S.D.A. at Washington, or a receiving market office, should be mailed the Federal Supervisor.

In forwarding telegrams, allow one (1) hour transmission and delivery. Allow also for the difference in time between the several time belts. If all these time allowances indicate that a message will be delivered after office hours, the telegrams should be sent under the night rate for next morning's delivery. For example: A telegram to Washington D.C. or New York City filed at a station on the Pacific Coast at 2:00 PM, allowing one (1) hour for transmission, plus three (3) hours for time difference, should be delivered about 6:00 PM. Such a telegram will usually serve its purpose just as well if sent night rate. (91)

GIVING OF TESTIMONY BY INSPECTORS

Regularly employed or licensed inspectors are expected to testify in court or at PACA hearings in cases which involve inspection certificates, when properly subpoenaed by the court or examiner or when requested by a PACA official to testify without subpoena. The Washington office should be notified, through the Federal Supervisor, for permission to testify when a request has been received or a subpoena has been served. Evidence may be given either personally or by deposition. (92)

Affidavits may occasionally be asked for, but are not so likely to be used because they are subject to objection by the opposing side. There is no objection to an inspector making an affidavit to facts within their personal knowledge in addition to those covered by their certificate, nor is there any objection to their making explanations of any fact stated on their certificate which might not be clear to those unfamiliar with the produce business. An inspector should not make an affidavit in their personal capacity. There is no such thing as a "personal" or "non-official" affidavit relative to official business. (93)

The Department feels that in suits in civil courts or in complaints under the PACA it is better to have inspectors testify personally than to depend on a certified copy of the certificate. As indicated above, this personal testimony may be given either in court, by deposition or affidavit. (94)

Inspectors who are called on to testify should always obtain the notes made at the time of the inspection for the purpose of refreshing their memories as to the number of samples taken and other details. In most courts and in hearings under the PACA, inspectors in being properly qualified as witnesses and showing that the notes were made at the time of inspection, will be allowed to refer to these notes while on the stand. (95)

- (96) Inspectors should realize that they are called as witnesses because of the belief that in this way additional and valuable evidence may be presented. They should, therefore, be frank in stating facts but can state only such opinions as are based on proper qualifications. For example, an inspector should not express opinions as to how rapidly decays will develop in transit for he has qualified as an inspector and not as an expert pathologist. Knowledge obtained from the publications of plant physiologists and pathologists does not qualify an inspector as an expert on such subjects. Only knowledge obtained by properly conducted experimental work in which he had a part will qualify a person as an expert witness. Very few inspectors can qualify as experts outside their own field and to attempt to do so may cause embarrassment.
- (97) Inspectors at shipping points are quite often in a position to see a large percentage of the commodity in a carload and as it is being run through the packing house. Under such circumstances, the knowledge thus gained should be mentioned in the inspector's notes and he may testify accordingly from information in the notes.
- (98) Inspectors should guard against being drawn into unnecessary or unrequested expression of conclusions or opinions. Ordinarily the opposing attorney would object to a question designed to lead to an expression of opinion or statement of a conclusion. However, many attorneys are so unfamiliar with the produce trade that they may not realize the exact purport of a question. If the inspector realizes that his answer would constitute an expression of opinion or statement of a conclusion, it is suggested that he preface his answers with some such statement as: "That is a matter of opinion" or "That calls for a statement as to my conclusion." This will provide an opportunity for objection and help to avoid being drawn into improper discussions. If properly qualified as a witness, however, the inspector has considerable latitude in the expression of his opinion along the line in which he is shown to be an expert.
- (99) If the inspector is asked as to the specifications of a grade, he should not volunteer discussion or explanation of the specifications. If asked specific questions regarding such specifications, they should be answered, if possible, but the inspector should avoid being drawn into a discussion.

FOOD AND DRUG PACKAGE MARKING REQUIREMENTS

In the paragraphs which follow there are outlined and briefly discussed the package marking requirements for food in packaged form under the Federal Food, Drug and Cosmetic Act approved June 25, 1938. The Act requires the containers of food in packaged form to be marked with: (100)

1. The common, or usual name of the food.
2. The name and place of business of the manufacturer, packer, or distributor.
3. An accurate statement of the quantity of contents in terms of weight, measure or numerical count, or a combination of numerical count and weight or measure.

Marking requirements pertain alike to all containers regardless of size. The required information must appear on the label or on the container prominently and with such conspicuousness and in such terms as to render it likely to be read and understood by the ordinary individual under customary conditions of purchase. The required information may appear on tags instead of upon labels printed or stenciled on bags, provided the tags are securely affixed to the bags and that they contain the required information in a conspicuous and legible manner. (101)

Open containers are subject to the same package marking requirements as closed containers, except that (1) containers of not more than one dry quart capacity are exempt, and (2) containers of a shipment moving interstate to a processing plant are exempt when certain conditions are met. (102)

The common or usual name of the food may not be required in the case of a common fruit or vegetable in an open container or in a container such as an open net bag, since the nature of the contents is obvious. (103)

A statement of weight shall be in terms of the avoirdupois pound and ounce. A statement of liquid measure shall be in terms of the United States gallon of 231 cubic inches and the quart, pint and fluid ounce subdivisions thereof. A statement of dry measure shall be in terms of United States bushels of 2150.42 cubic inches and the peck, dry quart, and dry pint, subdivisions thereof; or in terms of the United States standard barrel and its subdivisions of third, half, and three-quarters barrel. However, in the case of an export shipment, the statement may be in terms of a system of weight or measure in common use in the country to which such shipment is exported. (104)

- (105) The commodity must comply with the marked net contents at the time the lot or shipment comes within the jurisdiction of the Act. Therefore, the words, "when packed" are superfluous in any marking of contents. Allowance should be made in packing products which are liable to change in weight, so that the declaration of net weight will be true at the time the product becomes subject to the operation of the law. Shippers and growers may be advised that marking like the following are acceptable: "Net weight _____ lbs.," " _____ lbs. net weight," or "Net contents 1 bushel."
- (106) A grade marking is not required but must be correct if made.
- (107) Licensed shipping point fruit and vegetable inspectors have no responsibility for the enforcement of this Act, but they should report cases of misbranding as instructed in paragraphs 110-118. Shipping point inspectors should call to the attention of growers, packers and shippers, the marking requirements of the Act and recommend that where they are doing interstate or export business, steps should be taken to provide labels and bags properly printed with the necessary markings or otherwise have their containers properly marked.
- (108) The complete text of the Act is available in a 58-page circular, S.R.A., F.D.C. 1, FEDERAL FOOD, DRUG AND COSMETIC ACT AND GENERAL REGULATIONS FOR ITS ENFORCEMENT, available for 35 cents per copy from the Superintendent of Documents, Washington, D.C. Food branding requirements are covered on pages 13 to 18 of the circular.
- (109) In addition to the foregoing, all markings made mandatory by State regulations should be observed. In case of shipments destined for Canada, refer to the Canadian Import Requirements circular for information as to required markings.

PERISHABLE AGRICULTURAL COMMODITIES ACT

- (110) Inquiries. The P.A.C.A. is a Federal law regulating interstate and foreign trade in fresh fruits and vegetables. The law requires dealers to be licensed under the Act and establishes rules of conduct and procedure for the industry. Disputes between buyer and seller may be arbitrated under the Act. Shippers, when they have trouble delivering cars which have been inspected at shipping points, sometimes ask inspectors to whom wires of complaint under the P.A.C. Act should be sent. Such communications should be sent to the Regulatory Branch, Fruit and Vegetable Division, U.S.D.A., Washington, D.C. or to the nearest Regulatory Branch representative.

Inspectors should not attempt to advise growers or shippers as to their rights under the Act or attempt to interpret its provisions. (111)
Neither should they assume the responsibility of transmitting the complaint or inquiry of a grower or shipper. Such parties should be advised to communicate direct with the nearest Regulatory Branch representative. His address can be obtained from the Federal supervisor.

Misbranding. It is also unlawful under the P.A.C. Act for dealers to misbrand fresh fruit and vegetables as to grade, size, pack, weight, state of origin, etc. (112)

Notify Responsible Party and Record on Notes When Lot is Misbranded. (113)
Special notification shall be given to the responsible person immediately upon completion of inspection for any branded lots which do not meet the grade marked on the container. The inspector shall enter on the note sheet the following statement: "I informed _____ (Owner or shipper, if possible, or other responsible person) that this lot was misbranded at _____ (Hour) on _____ (Date) by _____ (Telephone call, verbal statement, or specify other means)

Be sure to notify the above at once so he will have the information before the car or truck is shipped. This statement should not be reported on the typed certificate, but is needed on the note sheet to assist in the successful prosecution of misbranding cases and will benefit the inspector whenever his testimony is required for such cases. Under normal circumstances this entry should not be made if the inspector knows that the lot was regraded or the incorrect grade marks were obliterated before shipment. If he has already notified the responsible person and made the entry prior to such action being taken, he should add a statement to the misbranding notification remarks saying that there had been regrading or obliteration. Also, if following notification, the misbranded lot is shipped, the inspector should enter the date of shipment, car or truck license number, and any other pertinent information that he may have. (114)

Occasionally lots of sweet potatoes, potatoes, onions and other products are packed in containers so weather beaten, stained, ragged looking, with colors faded, size markings old and often not applicable to the contents packed therein. The labels are also old, faded, somewhat torn but readable and may refer to several states which pack the product being offered for sale. PACA has ruled that such lots should not be handled as misbranded under the meaning of Section 2(5) of the Act.

- (115) Notify the Regulatory Branch of Misbranding Cases. All misbranding cases at shipping point which are detected in the regular course of performing inspections should be reported by leased wire or P.B.S. if available otherwise by commercial wire to the Chief, Regulatory Branch, Fruit and Vegetable Division, Consumer and Marketing Service, U.S.D.A., Washington, D. C. This wire should give the shipper's name and address, commodity, brand, grade or size mark, car or truck license number and consignee or destination if known, range and average of grade defects consisting of: (List defects in order of importance). In sending these notices, all lots which exceed the official tolerance specified in the grade standard should be included. Copies of the Act, and regulations issued thereunder may be obtained from the above address.

PACA RULING ON GRADE AND SIZE MARKINGS

- (116) The PACA position is that contents of containers marked for grade must also meet the size requirements of that grade. For instance, size B potatoes or 1-5/8 inch minimum stock in sacks marked only "U. S. No. 1" are misbranded. If marked "U. S. No. 1, Size B" or "U. S. No. 1, 1-5/8 minimum" they are not misbranded. But, if branded "U. S. No. 1" with tags inserted or attached showing the smaller size, the misbranding is not considered corrected. This applies to any commodity where size is specified in the grade.
- (117) When the lot does not meet the grade marked on containers, the certificate (whether handwritten or typewritten) should show that it "fails" to grade the marked grade. When showing percentage of U. S. No. 1 quality it is incorrect to state only "85% U. S. No. 1 quality" --show "Fails to grade U. S. No. 1 but contains 85% U. S. No. 1 quality".
- (118) Off-Count Under P.A.C.A.

In considering misbranding as to count, PACA applies the following tolerances:

- (1) When the U.S. Standards do not provide a tolerance they allow:
 - (a) an average 5% off-count tolerance for the entire lot. Individual containers (high sample) would be permitted to contain 10% off-count provided the average for the entire lot is 5% or less;
 - (b) when terms such as "approximate count" or "approximately" are used on containers in conjunction with a specified count, they will allow an average 10% off-count tolerance for the entire lot. Individual containers (high sample) will be permitted to contain 15% off-count or 1-1/2 times the tolerance provided the average for the entire lot is 10% or less;

Consequently "Approximate Count" should not be reported under the Grade heading. Lots may be reported under the Size heading as conforming or failing to conform to "Approximate Count" marked.

(c) in applying the tolerances under (a) and (b) for individual containers (high sample) where the average for the lot is within the specified percentage, they will allow one container to exceed the high sample tolerance before considering the lot misbranded.

- (2) When the U.S. Standards do provide a tolerance for a specific count but there is no provision for "approximate count" or "approximately", and either of these terms is used, they will allow double the tolerance provided in the standards.

When certifying count under a U. S. Standard, the inspector should report the range in count or "conforms to marked count" under the "Size" heading and report: "Meets (or fails to meet) count as marked" under the "Grade" heading. (119)

When certifying count under the PACA ruling, such as an "approx. count," the inspector should report the range in count or "Conforms to marked count" under the "Size" heading on the certificate but should make no reference to count under the "Grade" heading on the certificate.

CLERICAL AND OFFICE INSTRUCTIONS REGARDING CERTIFICATES

Typing the Certificate. Certificates are the product of our inspection operations and go to the offices of commercial firms throughout the industry, to other Government agencies and are used as evidence in court. Spacing and typing should be done neatly so that they will have an attractive and business-like appearance. (120)

The snap-out carbon certificate should enable typists to turn out legible carbon copies without difficulty. These are bound with black carbons so black ribbon should be used in the typewriter. (121)

When handwritten certificates (such as FV-184s) are used, care should be taken to see that they are legible and neat in appearance. Remember, they also often go to brokers, receivers, bankers or government agencies all over the world. A hard surface should be under them when they are being written. Always check the bottom copy in the set after writing the certificate to see that it is legible. A certificate that cannot be read is worthless. (122)

- (123) Certificate Numbers. Certificates are numbered serially. Every certificate must be accounted for. The printed series letter, if any, which precedes the number should be included whenever the certificate number is typed or quoted. USE CERTIFICATES IN SERIAL NUMBER - USE LOWER NUMBERS FIRST.
- (124) The certificate number should always be typed one space below the printed certificate number in the upper corner of the certificate. This is necessary so that all copies of the certificate will bear the same number as the original in case there is an error in the printed numbers on the copies that is not detected by the typist.
- (125) In the process of printing the "snap-out" carbon certificates, complete sets are sometimes spoiled and it is not practical to print replacement sets. The printing order is delivered short such numbers. When a package of certificates, as received from the printer, is opened in the office that is to use them, they should be checked to ascertain that all the numbers indicated on the packages are included. If sets of certificates are found to be missing, the office from which the supply was received or ordered should be notified promptly.
- (126) Occasionally the printing office makes an error in binding the original and copies of certificates, and the serial numbers on one or more of the copies do not correspond with that of the original. When this is noted before typing, it may frequently be corrected by moving one or more out-of-place copies to the original of the corresponding number and extra copies substituted where the shortage occurs. . . A misplacement of this kind frequently runs through several sets of certificates. If more than two copies are missing from a set, the set should be voided rather than substitute a large number of copies. Any set voided account incorrect numbering should be marked "Voided Account Numbering." The State office file must always be furnished with a copy with serial number corresponding to that on the original. Typists should form the habit of checking to see that the serial number on each copy agrees with that on the original.
- (127) The extra certificate copies supplied sometimes carry a printed serial number with the prefix letter "C". In typing certificates which include extra copies, the serial number of the original certificate must show legibly on all copies as instructed in paragraph 120. The "C"

- (133) Under the "Grade" heading capitalize all letters in the grade name, except where the lot is stated as failing to grade. In the case of combination grades, be sure to capitalize the AND, as -- COMBINATION U. S. NO. 1 AND U. S. NO. 2; other wise, confusion may result in naming the series of grades found in the load.
- (134) Apostrophe Marks. In the expression "Loader's count" and "Various growers' marks" the typist should not omit the proper apostrophe marks even though they may have been omitted by the inspector.
- (135) Figures, Percentage Marks. Figures should be used in the body of the certificate. Fractions, in order to be legible on all carbon copies, should be written thus: 1/2, 1/4; never $\frac{1}{2}$, $\frac{1}{4}$. The sign % is properly used on the certificate to indicate percent. 1/2 of 1% is to be used; not 1/2%, which may be interpreted to mean 50%.
- (136) Sizes. The sizes, counts, or packs which appear on packages are to be typed without apostrophe marks: Thus 96s to 216s, 3s to 12s, 4x5s to 6x6s, 2-1s, 2-2s and 3-2s.
- (137) Abbreviations. Use these in the body of the certificate only when crowded for space except "U. S." in grade names which should always be used in the abbreviated form.
- (138) Unused Headings. Block out thus: ///////////////. Or, follow with three or four spaced x x xs.
- (139) Place for Signature of the Inspector. Type the name of the inspector just below the dotted line so that it will be shown in carbon upon the copies unless the certificate is to be signed by the supervising inspector, in which case it should be typed above the line.
- (140) Initialing by Typist. In a large office where several clerks are typing certificates, the supervisor should require each person typing certificates to use an initial or set of initials which do not duplicate those of another typing in that district and to type this initial in the lower left hand corner of each set of certificates which he or she types.
- (141) Comparing Typed Certificate with Inspector's Notes. If the inspector cannot check the typed certificate himself, the typist and the inspector in charge or supervisor should not fail to do this, paying particular attention to car number, percentages, and grade statement, preferably checking them against the figures on the back of the note sheet.

When handwritten certificates (FV-184) are used, supervisors or key- (142)
men should check each certificate carefully against its field notes in
order to detect errors that might be made by the inspectors on the job.
When a material error is found, a "Superseding Certificate" should be
issued.

When More Space Needed on the Certificate. If inspection of a car- (143)
lot covers two or more varieties or brands of a single product and the
certificate does not afford enough space on the face to type all the in-
formation necessary to furnish a complete report, the original and all
copies should be turned over and completed on the back with the proper
headings. When a single product, variety or brand is entirely described
on the back, the following statement should be made under a "Remarks"
heading at the bottom of the certificate: "Certificate continued on back."

If more space is needed under only one or two headings, such headings (144)
may be carried over to the back. The portion of the statement on the cer-
tificate should be followed by the notation "Continued on back," which
should bear the same heading followed by the word "Continued," after which
the remainder of the statement should be made.

When a description of the products in a mixed car requires more space (145)
than is available on a single certificate, two or more separate certifi-
cates should be issued each covering one or more products depending on
circumstances. All certificates on such a mixed car should bear a cross
reference under a "Remarks" heading somewhat as follows: "For reports on
carrots and beets in this car, see Certificate number-----."

ISSUANCE AND DISTRIBUTION OF COPIES OF INSPECTION CERTIFICATES

Original inspection certificates shall be issued only to applicants (146)
or their authorized agents. Under the provisions of Section 51.21 of
S.R.A. 93, Revised, the applicant is entitled to four carbon copies of
the certificate in addition to the original for the regular fee, pro-
vided the request is made at time of application for inspection. In most
areas applicants only request the original and one copy except when the
inspection is under a special program for export.

At least one copy of the certificate, accompanied by the corres- (147)
ponding inspector's notes and any other papers related to the inspection,
is to be filed in the State as the State supervising officer may direct.

(148) The original and copies of the regular shipping point certificate are generally to be distributed as follows, however, minor variations may be made when necessary to facilitate operations:

- Original - to applicant.
- 1st carbon - to district office file in case the state maintains permanent district offices.
- 2nd carbon - to applicant.
- Remaining copies - to be held in local office or filed with inspector's notes unless asked for by applicant, either individually or as a blanket request.

(149) If the certificate covers a commodity moving under a marketing agreement, the 5th carbon is mailed by the Inspection Service, as a matter of accommodation to both the control committee and the shipper, direct to the manager of the control committee administering the agreement, reducing by one the copies available for further distribution. Control committee copies are mailed under postage since the members of such committees are not Federal employees. It is sometimes necessary to type extra copies when such programs are involved.

(150) There may be other Government controlled marketing programs under which inspection will be required and a copy of each certificate requested by the agencies which administer the program. The Federal Supervisor will issue instructions in such cases.

(151) Truck lot or short form certificates for all products other than marketing agreements are distributed the same as the regular shipping point certificate (See paragraph 148).

(152) If the shipment includes a marketing agreement commodity, the truck lot certificate is distributed:

- Original - to applicant
- 1st carbon - to state or district office file with inspector's notes.
- 2nd carbon - to manager control committee.
- Other carbons - file with inspector's notes or to applicant if requested.

- 33 -

If the applicant should request additional copies of short form certificate, the inspector will have to write out an additional set by voiding the original of a second set, with the certificate number of the additional copies changed to conform with the original of the first set. The voided original should contain a notation that it was voided to make copies. This original and any extra copies should be retained in the local files for auditing purposes. (153)

CORRECTING, VOIDING AND SUPERSEDING CERTIFICATES

In the paragraphs under this heading a distinction is made in the handling of corrections on certificates before and after issuance. "Issuance" as used here, means the actual delivery of the certificate to the applicant or his agent, or others outside the Service. The following instructions apply both to typed and handwritten (FV-184) certificates. (154)

Minor Corrections Made in the Course of Typing or Prior to Issuance. (155)
If the correction is not conspicuous and the portion in error is minor so that it would not be likely to affect the value of the certificate if presented in court, it may be changed by erasure, provided the same typewriter is used as in the original typing; however, care should be used to keep such errors to a minimum. Any erasures should be neatly done. The inspector should initial all erasures and corrections.

Correction of Material Errors Prior to Issuance. Erasures should (156)
not be made on certificates where vital parts are involved, such as car numbers, dates, percentages and general terms, or where they would give the certificate an unattractive appearance. Under such circumstances, the certificate should be stamped or marked "VOID" across the face of the original and all copies and a new certificate typed. Of the voided certificate, one copy should be sent to the usual state files and the original and remaining copies retained in the local files for auditing purposes. If the state copy has been mailed before the error is found, a Notice of Correction (See paragraph 162) must be prepared to advise that the certificate has been voided.

Corrections After Issuance. When material errors are found in a (157)
certificate that has been issued, every effort should be made to recover the original and all copies. However, regardless of whether or not the original and all copies are recovered, a new certificate should be issued to replace it bearing a new certificate number, a correction of the error and the words "CORRECTED CERTIFICATE" typed in capital letters in one of the upper corners of the certificate. Under a "Remarks"

heading, following the "Grade" heading, the following statement should be typed: "This certificate supersedes certificate No. _____." In all other respects, including the date, the corrected certificate should be identical with the first certificate. Copies of the Corrected Certificate should be sent to all persons to whom the first certificate was issued.

- (158) The original and all available copies of the incorrect certificate should be plainly marked or stamped across the face: "Superseded by Certificate No. _____." (Do not mark VOID). One copy, together with a Notice of Correction, should be sent to each of the usual files. The remaining copies, together with a Notice of Correction and copies of correspondence requesting the return of the incorrect certificate, should be retained in the local files.
- (159) After a certificate has been issued, it is not permissible to make corrections on the original and/or part of the copies. If corrections are to be made, be sure they are made on the original and all copies, and that the corrections are identical.
- (160) Members of the trade holding originals and copies must never be directed to make corrections themselves.
- (161) Signing or Initialing Corrections. Under some circumstances, it is impractical to issue a Corrected Certificate to correct an error. An example is an error made in typing an Export Form certificate, the number of which has previously been issued on a Memorandum of Inspection. Under such circumstances the error may be corrected on the original and all copies if it is initialed at the place of correction by the inspector or supervisor who signed the certificate. When another supervisor approves the correction, his full signature and title is necessary at the nearest convenient point to the correction. Initials must be in the same style as the signature - not printed. Special care must be exercised to avoid the necessity for such corrections. When the file copy has been mailed, Notices of Correction must be sent to state files.
- (162) Notice of Correction Report. When corrections are made on certificate of which a copy has been sent to the state files, a Notice of Correction Report must be prepared to clearly explain the situation. When superseding certificates are issued, they must show the numbers of the superseded and superseding certificates and the car initials and number of state lot number, if any.

Notices of Correction need not be prepared where the original and all copies, including the state files copies are still in the issuing office as they can be marked or stamped VOID and disposed of as directed in paragraph 156. (163)

Two copies of the Notice of Correction are prepared whenever this report is necessary. One copy is mailed to the state office files and one copy is to be filed in the local office files or is to be mailed to the Federal Supervisor as instructed. (164)

Corrections Outside the Originating District. All corrections on issued certificates should be made either by the issuing office or in the office of the Federal Supervisor. In rare cases, it is necessary that a correction be performed by another local office. Such a correction shall be made only on telegraphic authorization or confirmed telephone authorization from the supervisor in the originating district. A correction on a shipping point certificate issued in another state may be made only on authorization from the Federal Supervisor. Usually the certificate is sent back to the state of origin for correction. (165)

Notices of Correction reporting the correction and citing the authority for making it should be prepared in the office making the correction and, in addition to the regular copies, should be sent to the state and Federal Supervisor's files in the issuing state. (166)

FURNISHING REPORTS

Occasionally a telegraphic request is received from a firm in a market asking for a report of the shipping point inspection of a lot. The question arises in such a case as to whether the requesting firm is entitled to receive the information. If the firm making the request has signed a contract to purchase the lot, has accepted delivery of it, or has taken any other action which places it in the position of a financially interested party, the firm is entitled to a report of the shipping point inspection. If the interest of a firm is merely that of a prospective buyer who has not signed a sales confirmation or contract to buy, it is not entitled to receive information from the inspection of the lot in question. (167)

- (168) If the applicant for the inspection can be communicated with by local telephone or for a small toll charge, call him and ask if the inquiring market firm is entitled to a report on the shipment. If the answer is in the affirmative, wire the report of the inspection direct (collect) to the market firm. If the applicant's answer is negative, wire the market firm (collect) for a statement of their financial interest. If such interest is not adequate, the report should be denied. In approaching the applicant in a case of this type. The shipping point office is seeking only reliable information as to whether the inquiring market firm has or has not a financial interest in the car or shipment. The permission of the applicant to give the report to the market firm is not necessary if the market firm has established a legal financial interest in the shipment.
- (169) In any case where a wired report of a shipping point inspection is made, the office making the report is entitled to mail a copy of the certificate to the requesting firm, together with a bill for the established fee. Copies of all wires and letters in connection with a certificate should be attached to the file copy of the certificate that is attached to the field notes.

FURNISHING ADDITIONAL CERTIFICATE COPIES

- (170) A person, other than the applicant, requesting copies of a certificate should have the same qualifications as to financial interest as one requesting a wire report.
- (171) When requests for additional copies are received prior to typing the certificate, additional copies may be inserted and typed along with the original. If the number of copies needed are in excess of those that may be typed with the original or a request for additional copies is received after the original is typed, a second typing may be made. Copies in addition to those in the set with the original shall be made on blue extra copy sheets of the corresponding kind of certificate. This typing shall carry the typed number and date of the original certificate. (See paragraph 124).
- (172) Lost Original, Charge for Extra Copies. When a request is received for "another original" of a certificate because the "first original" has been lost, the applicant should be advised that there can be only one "original." The only action the Inspection Service can take is to issue one or more copies, according to the procedure described in the preceding paragraph, or to attach to a copy of the first typing a white slip with the following statement:

This is a carbon copy of certificate _____ covering car
(number)
_____, a like carbon copy of which is in the official files
(number)
of this office.

(Signed) _____
(Title)

The charge for extra copies shall be in accordance with the state's (173)
schedule of charges for shipping point inspection service.

FURNISHING CERTIFIED COPIES OF CERTIFICATES

A certified copy of a certificate is one that is certified by the (174)
Secretary of Agriculture as being a true and compared copy of the official
copy on file. The applicant for such a certificate should be advised that
such certification is done in Washington, D. C. If the applicant sends in
a copy there will be no charge for having it certified. If the Inspection
Service has to provide the copy, the charge will be \$2.25.

HANDLING CERTIFICATION SUPPLIES

Accounting for Certificate Forms. All certificate forms must be (175)
accounted for to both the Federal and State Departments by reference to
the serial numbers. When a certificate must be invalidated for any
cause, the original and all copies should be marked or stamped on the
face in large letters either "VOID" or "SUPERSEDED BY CERTIFICATE
No. _____," as the case may be.

Records of the receipt and distribution of all serially numbered (176)
forms should be maintained by all inspection offices within the state.
When blocks or books of numbered certificates or other serially numbered
forms are received or issued to field offices or to individual inspectors,
the records kept must make it possible to locate a given numbered form at
any time, or to place responsibility if it cannot be located. Such forms
should be carefully checked when received to make certain that the
receipt corresponds to the manifest or requisition. Missing, torn and
mutilated certificates must be recorded as well as usable ones.

- (177) Distribution of Certification Supplies. In handling of accountable joint Federal-State certification forms, a certain procedure should be followed because of (a) the necessity that forms be available at all times at many points (b) the desire of both State and Federal accounting agencies that the use of forms may not be spread out over a long series of numbers with many intermediate serial numbers remaining unused for extended periods. It is also desirable that there shall be no inter-district transfers of fragmentary lots of unused certificates. Any certificates which cannot be used within the district to which originally allotted by the time other closeby numbers have been used elsewhere in the state, should be sent to State headquarters for redistribution.
- (178) In some states all certificates are typed in two or three offices. In others, the offices are seasonal and all supplies go back to the headquarters office when the season is over. In such states there will be no difficulty in distributing certificate forms and using them without serious breaks in numerical sequence. In each state where certificates are allotted to a number of offices, a plan should be worked out so that all offices will be issuing reasonably close serial numbers at a given time. This will involve more frequent allotment of supplies, especially to those offices which put out a small number of certificates. The distribution of certificates in each state must also be worked out with full consideration of state requirements as to the accounting for such documents.
- (179) The joint Federal-State forms which must be accounted for to both the Federal and State Departments are: All regular certificate forms, the truck lot form, or any numbered short form certificate, and copies with serial numbers prefixed by C.
- (180) An inspector who must keep detached sets of handwritten forms or short form certificates with him, will find that if they are placed between about four cardboard backs from certificate pads of other stiff protective material held together with two of about size 64 elastic bands, and enclosed in a 9-1/2 x 12 FDA craft envelope, the forms will remain in good condition for use. When this form is to be written, one set should be removed from the pack in which it is carried and the set clipped next to the metal of the inspector's clip board. Do not attempt to write this form over other papers.

Keep Accountable Forms in Locked Storage. It is recommended to all (181) offices and individuals of the joint Federal-State Inspection Service who have blank certificate forms in their care, that reasonable care be exercised against such forms being stolen or falling into the hands of persons unauthorized to receive or have such forms in their possession. Where facilities permit, the reserve storage of numbered certificate forms should be kept in locked storage, only the pads in current use being kept on the desk.

Preservation of Certificate Files. It is a Federal requirement (182) that a copy of any Federal document in connection with the issuance of which a fee is charged, must be kept in the office of issue at least 5 years. Official certificate files in the State must be preserved 5 years from date of issue, after which they may be destroyed.

PART II

MAKING THE INSPECTION AND KEEPING NOTES

- (183) Sampling. Adequate and representative sampling of a lot is vitally important to accurate certification. Without such sampling the certificate may be in error regardless of how well the remainder of the inspection is made or how well the certificate may be written. More shipping point certificates are reversed in the markets because the samples on which they were based were not representative of the lot than from any other cause.
- (184) It is essential that samples for inspection be properly representative of the entire lot. Proportionate numbers of samples should be taken from each grower's lot, variety, brand, grade or other lot designation in a car. When the inspector's station is at the end of a packing line, as in vegetable sheds or fruit packing rooms, sorter or packer numbers should be considered in selecting samples. If one half of a lot is uniformly good and the other is distinctly inferior, an equal number of scores should be taken from each half. An average figure would not be representative if a greater number of samples were scored from either half. However, it might be necessary to examine, without adding to the scorings, a greater number of samples from the poorer half to determine that the samples scored were properly representative of the lot. When inspections are made of lots blocked out in a warehouse or storage, samples should be selected from lower layers as well as from the readily accessible top layers.
- (185) When the inspection is made after the car is partly or completely loaded, containers to be sampled should be taken from various locations in the car or lot and should include containers from the lower layers and from stacks nearer the bunkers as well as from the more readily accessible upper layers or stacks near the doorway. Inspectors should always have in mind the possibility that selected packages may have been placed where they would be most available as samples.

40(a)

****The inspector is responsible for seeing that the product is (186)
representatively sampled and for maintaining the integrity of the sampling
process. While it is desirable that an inspector pull his/her samples,
except in cases where the inspector oversees the sampling process, the
inspector must always select the samples. In areas where product is staged
in cold storage rooms, on stacking racks, or palletized, the inspector may
stamp or mark packages which he/she has selected as samples and
packinghouse or warehouse personnel may physically obtain such packages and
bring them to an inspection area for the inspector.****

****Samples which are not selected by a licensed aide or inspector are (186a)
considered "submitted samples." A certificate covering such samples should
show under "Number of Containers" only the number of packages provided or
the weight of the total sample. Do not show the total number of packages
the submitted sample is supposed to represent. A statement should be made
under "Remarks" clearly identifying the certificate as being based on
submitted samples. For example: "Certificate based on samples submitted
by Henry Smith of the ABC Packing Company."****

Samples From Open Containers. There are many instances when samples (187)
are taken before packages are lidded or closed, but in all such cases notes
recorded from such samples should be checked carefully with samples from
lidded containers, as there is a possibility of bruising occurring in
closing or stacking the containers. In the event of a difference in these
samples, the certificate must be based on the samples from the closed
containers. If rough handling that might damage the product is observed in
loading, the samples should include packages selected from the load that
would reflect any damage occurring.



Observations Prior to Packing. Very often the inspector is able to observe large quantities of the product being harvested in the field, in the packing house in field containers or as it goes over the sorting belts. While the results of such examinations are not shown in detail on the score sheets, it is very important that they be made whenever possible. They will assist the inspector in selecting representative samples and unusual conditions should be noted on the score sheet. This is intended to supplement, not reduce, the regular sampling. The grade must be based on the analysis of actual selected samples and not on an estimate made from watching the sorting belts or bins. (188)

Number of Samples. No definite rule can be laid down as to the number of samples which should be examined because of the variations of conditions that may confront the inspector. A straight carload of one variety and grade put up by a single grower will obviously need less sampling than a carload containing a mixture of varieties, grades or growers' marks. Any sample that differs materially from the other should put the inspector on warning that the lot is irregular and that more samples should be taken. The responsibility rests with the inspector, under general instructions from his Federal Supervisor, to examine enough samples to assure himself that the certificate he issues will accurately describe the entire lot. It should always be kept in mind that the smaller the number of samples examined, the less chance exists for correctly determining the range of variable factors and the true average for the lot. A larger number of smaller samples will usually give a more accurate average than a fewer number of large samples. (189)

Lots Bordering on the Tolerance. When the inspector, after examining the usual number of samples, finds the average of defects equals the maximum grade tolerance permitted or slightly exceeds this tolerance, he should, if at all possible, examine more samples so that the lot may be put definitely in or out of grade. Shippers sometimes become quite critical when lots are reported out of grade by only one percent unless they can be shown that more than the usual number of samples have been examined. (190)

Additional Samples. Sometimes when the inspector has examined the usual number of samples, he may still be in doubt on some point. In this case he should examine more samples, perhaps casually, until the uncertainty is cleared up. He should record on the note sheet that such further examinations have been made, showing the approximate number of additional samples examined. For example: When the inspector finds some packages which contain the limit of dirt permitted by the grade and suspects that some packages may contain more than the limit, he should open enough packages to determine definitely whether or not the lot is in grade. (191)

- (192) Size of Samples. No specific rule can be laid down as to the size of samples to be examined. This, like the number of samples, must be left to the judgment of the inspector subject to the instructions issued by his supervisor. It will vary with the type of commodity, kind of containers and the percentage of defects found. It is desirable that samples be as nearly uniform in size as possible. However, special container tolerances for percentages of defects in individual packages may make it necessary to examine larger samples or entire packages. Generally no lot should be put out of grade on account of a sample exceeding the container tolerance unless the entire contents of the container have been examined. In products where there is an excessive number of specimens in a package such as peas in hampers, onion sets in 50-pound sacks, etc., it is impractical to examine the entire contents. In such cases the usual sample should be at least doubled in size. The same policy applies to samples taken from packing bins or tables. Always use the term "sample" when only part of the contents of the container is examined, as: "In most samples -----, in some samples -----." When the entire contents are examined it is proper to name the container as "In most sacks -----, in some sacks -----."
- (193) Selected samples should be accurately counted or weighed, as the case may be, unless the sample is the entire contents of a uniform content container. In using barrel type scales, be sure the cylinder works freely in the barrel and that the scales are held by the ring when the reading is made. Scales should be checked periodically for accuracy.
- (194) Adequate light is essential to accurate inspections. In packing sheds the inspector's bench, table or station should be placed where ample light is available. In judging the blanching of celery, color of grape-fruit and oranges, or the percentage of color on grapes, it is desirable to examine doubtful specimens in daylight before reaching a decision.
- (195) Average Sample Scorings. When the size of samples is not uniform, the percentage of defects should be determined for each sample. The percentage for all samples should be totaled and divided by the number of samples examined in order to determine accurately the average percentage of defects for the lot. When samples are reasonable uniform in size, it will be satisfactory to divide the total weight or count of defects by the total weight or count of all samples to determine the average percentage of defects.
- 196) When the Contents of a Consumer Package is the Unit for Inspection. When consumer type packages are packed in master containers or shipping cases, the consumer package is the unit for inspection, and it is not permissible to dump the contents of two or more of these packages together to form the inspection sample, except when the inspection is based on consumer or other standards which specifically provide that there is no restriction on the percentage of defects permitted in individual packages provided the average is within the tolerance. However, in the case of

-43-

such products as cauliflower, lettuce, celery, or other products when one or a few specimens are sometimes overwrapped in film or packed in film bags, trays, or other such containers, the contents of the master container shall be considered the fruit for inspection the same as for tomatoes which are double wrapped and packed in lugs.

Sampling from Packing Bins. When product is being wrapped, packed, and loaded in so short a time that the inspector would not be able to examine a sufficient number of closed containers, it will be permissible to record counted or weighed samples selected from packing bins, if the circumstances are approved by the Federal Supervisor. However, some samples must be examined after the packages are closed to determine if there is package bruising and to determine the tightness of the pack, arrangement, and sizing of the containers. A notation should be made on the scoresheet indicating which samples were selected from bins if this procedure is followed. Containers packed in the inspector's absence should always be included when selecting samples. This is of paramount importance. (197)

**** **Cutting Specimens.** It is sometimes necessary to cut specimens in order to determine the percentage of internal defects such as hollow heart of potatoes, internal breakdown of onions, internal browning of apples, concealed worms in pears, etc. While it is not the policy of the Service to cut large amounts of produce, it will be necessary to check the internal quality as a matter of procedure. The application for inspection may be rejected if the applicant objects to the inspector cutting an adequate number of specimens to determine the interior quality or condition of the product. Unless specific cutting plans are outlined in the respective handbooks the following procedures shall be used to determine and record the percentage of internal defects. (198)

Cutting Policy for Commodities Without Specific Cutting Plans (198a)

During the normal process of inspection, it is the inspector's responsibility to randomly cut a sufficient number of specimens to examine the internal quality of the product. When it has been determined that internal defects are present through this random sampling, in order to promote uniformity of inspection for internal defects (without external indicators) the following sampling plans, when applicable, shall be used as guide. These plans are to be used for those commodities without specific cutting plans outlined in their respective handbooks. The percentages of internal defects shall be based on the cut sample. When it is impracticable to apply the following guidelines, it will be necessary to cut a sufficient number of specimens, and base the percentages on the entire sample.

-43a-

(198b)

Cutting Procedures and Guidelines

In order to promote uniformity of inspection for internal defects (without external indicators) for those commodities without specific cutting plans, the following sampling plans, when applicable, shall be used as a guide. When it is impracticable to apply the following guidelines, it will be necessary to cut a sufficient number of specimens, and base the percentages on the entire sample.

Plan A shall be used only for in-line sampling to minimize the cutting of unaffected fruit. Plan B shall be used for stationary lots and may be used for in-line inspection at applicant's request. Under each plan, the number of specimens cut shall be used to compute the percentage of defects for the lot and the individual containers.

(198c) **Plan A:** (For in-line Inspection only)

When it is evident that internal defects are present in the lot (through the normal process of inspection), a random sample of five (5) specimens shall be cut from each sample. When any scorable (*internal defect*) specimen is found in the five (5) count sample, cut an additional fifteen (15) specimens for a total of twenty (20) specimens in the cut sample, or a total of five (5) pounds for those commodities inspected on a weight basis.

When a cut sample meets the application of tolerances for the commodity, no additional cutting for that sample is necessary. When a cut sample exceeds the application of tolerances for the commodity, the entire lot represented by the sample, regardless of count/size or pack, will fail.

Whenever any container is found to exceed container tolerances, it will only be necessary to cut five (5) specimens per sample for the remainder of the samples within the lot.

(198d)

Plan B: (For Stationary lots and In-line inspection)

When it is evident that internal defects are present in the lot (through the normal process of inspection), a random sample of five (5) specimens shall be cut from each sample. When any scorable (*internal defect*) specimen is found in the five (5) count sample, cut an additional fifteen (15) specimens from the sample (total of 20 specimens cut) or a total of five (5) pounds, for those commodities inspected on a weight basis.

-43b-

When a cut sample exceeds the application of tolerances for the commodity, the cut sample shall be increased to the entire container, or to the normal sample size for those commodities with application of tolerances which are based on the sample, in order to determine if the container has met or exceeded the sample or container tolerances.

When it is found that container or sample tolerances are exceeded in one of the samples, it will only be necessary to cut twenty (20) specimens or a total of five (5) pounds in each of the remaining samples.

For those commodities based on ounces or grams, (i.e., Brussels sprouts), the cut sample shall consist of at least one half of the sample.

When the sample is based on consumer units, the entire sample shall be cut.

Note: For In-line inspections it will only be necessary to cut five (5) specimens from each of the remaining samples to determine if the lot has passed or failed. For Stationary lot inspections shall cut a minimum of twenty (20) specimens or a total of five (5) pounds from each of the remaining samples in order to provide a more accurate percentage of internal defects.

When external indicators for internal defects are present, the inspector shall cut the suspicious specimens as necessary and base the percentages on the entire sample.

Avoid Causing Inconvenience In Making Inspections. When inspections are made during the process of loading, the inspector should avoid unnecessary interference with the loading operation. He should ask shippers to furnish information regarding inspections, which they will request, far enough in advance so that it will not be necessary to disturb the portion of the car already loaded in order to obtain samples. However, thoroughness must not be sacrificed for fear of causing inconvenience. Some shippers may try to stampeded the inspector for rapid loading in order to reduce the number of samples examined and so make possible the inclusion of undergrade products.

(199)

- 44 -

- (200) Inspectors' Notes. Each certificate is to be based on notes made at the time of the inspection. Printed note sheets (in many areas bound into pads) are furnished so that the notes may be kept in a standardized and orderly manner. All sheets or slips upon which such notes are made become part of the permanent record of the inspection and should be attached to the copy of the certificate which is retained in the files of the State.
- (201) All notes must be legible and so complete and clear in meaning that any person with a knowledge of inspection work could write the certificate from these notes without having personally made the inspection. Be sure all items covered by the certificate are recorded, all computations clearly and accurately shown, and no essential data overlooked. All this information should be carefully checked before beginning to write the certificate. When note sheets, subpoenaed by the court or called for in P.A.C.A. cases, are complete, accurate and neat, they are a credit to the service. A poorly kept note sheet is almost prima facie evidence of a careless inspection.
- (201a) *The Federal Supervisor may authorize the use of master notesheets provided *
*that suitable cross-referencing procedures are followed. *
- (202) Preparing the Score Sheet. It will be necessary for the new inspector to have personal instruction from some experienced inspector in the preparation of his score sheets. On certain products special instructions are provided in the products handbooks or will be furnished by the supervisor. Aid is provided in some states by printing the headings at the top of the score sheet or by providing caption stamps. It would be impracticable here to give complete instructions covering all the problems the inspector may encounter, or to furnish examples of complete score sheets that would apply to all products. Some of the more important factors of general application to all products, with instructions for assisting in making a concise and complete note sheet, follow in the next paragraphs.
- (203) Recording the Scorings. The information recorded on the score sheet is the basis on which the certificate is written. The findings must be accurately reported on the score sheet by count, weight or in general terms, depending on the factor involved. The headings generally required will be those covering the size of the sample examined, decay, different kinds of defects (often each having a separate column and heading) and such factors as size (which may include uniformity or range), color, cleanness, maturity and pack. The headings may vary considerably with different products and it sometimes may be necessary to split certain headings into sub-headings. For example, where the grade provides different tolerances for soft rot and dry types of decay, these will have to be listed in separate columns. In handling products where the grade provides a smaller tolerance for serious damage, the serious defects, when present, must be recorded separately from the minor defects. Under the size factor too, a column for undersize, sometimes for oversize, and very often columns showing the "size range" and the "mostly" are required.

Somewhat similar conditions exist in regard to the color heading, but maturity, cleanness and pack seldom require more than one column, particularly where symbols and letters are used in the interest of brevity and to indicate proportions and degrees.

The preparation of the score sheet becomes considerably more complicated where there are a number of growers' lots, varieties and grades, with possibly a combination grade. Also additional headings may be necessary where State regulatory laws require the correct marking of packages and the applicant desires to know the grade and size he should mark on his containers in case the original markings are incorrect. (204)

Symbols Suggested For Use on Score Sheets. In order to conserve space and to speed making of notes, the following abbreviations are suggested to be used on score sheets. Similar symbols may be developed by the inspector for other factors. (205)

Pack: T, Ft, or S (tight, fairly tight or slack) or
W, F or S (well filled, fairly well filled or slack).
Size: U, Fu or I (uniform, fairly uniform or irregular).
Color: G, Lg, Yg or Y (green, light green, yellowish-green or yellow)
Maturity: H, F, Fr, R or S (hard, firm, firm ripe, ripe or soft).

The more prevalent condition is indicated first and less frequent in their order.

To indicate the portions of a sample, the following symbols are suggested. (206)

The use of a single letter indicates the condition to be general.
A circle around the letter indicates "mostly".
A double underlining of the letter indicates "many".
A single underlining of the letter indicates "some".
When two letters are used with no symbol, the first letter indicates "generally" and the second "few."

Examples: (207)

Size: (M) L S (Mostly medium, many large, few small).
Maturity: (H) F Fr (Mostly hard, some firm, some firm ripe).
Pack: Ft-S (Generally fairly tight, few slack).
Color: GG (Generally green)
G (Green)

- (208) It is desirable that the above-suggested symbols be used by all inspectors, however, others may be found more adaptable or satisfactory under some conditions. Regardless of the symbols used, they should be uniform as far as practical throughout a state or larger inspection area, to avoid confusing or conflicting interpretations when inspectors or supervisors are transferred from one district to another. Uniformity of certificate wording and arrangement is also desirable. Such uniformity will aid the person who reviews the inspector's notes before typing and will facilitate the reading of his notes should it be necessary to refer to them in his absence at a later date. Uniformity of wording and arrangement is also an aid to typists who frequently must type dozens of certificates a day.
- (209) Entries Under the Headings Pack, Size, Color, Shape, etc. A record for each sample should be made on the note sheet under the proper headings as they apply to the commodity. Ditto or check marks may be used when the notation is the same as in the last sample, however, the inspector should not become careless in his use of such marks, but should be sure to record any variation in the samples by means of symbols. Carelessness in the use of check or ditto marks often will cause inaccurate certification.
- (210) Identifying the Product and Container. With a few exceptions the type of container, style of pack, variety and grade should always be recorded at the top or at some other place on the score sheet. In some instances, headed columns should be provided for these factors. However, where such items are generally uniform throughout a district (such as container and pack of northwest winter pears) such headings are not necessary unless they vary from the general condition.
- (211) Check Items at Bottom of Score Sheet. Most note sheets have headings printed on the back near the bottom for car and load description, labels, sizes and summaries of pack, color and maturity as well as for grade and time. This portion of the note sheet should always be filled in while making the inspection. When oral report is given to applicant, in lieu of written preliminary report at completion of inspection, notation should be made on inspection work notes as to hour, date and person receiving information. Example: Reported to John Doe 10:00 a.m. 4/2/59.
- (212) Recording the Car Number. It is imperative that car numbers should be correctly recorded. Errors in recording car numbers are inexcusable. Note sheets usually have spaces on the back and on the front indicated for car numbers. The inspector must enter the number in all places provided on the note sheet while reading the number from the car. Care must be taken not to transpose figures. When the inspector writes up his notes, he should compare the numbers in the various places on the note sheet and if differences are found, he should immediately check to determine the correct number.

-47-

The car number to be recorded is that on the side of the car. (213)
If a different number appears on the inside of the car (which may happen if the car has been repainted and a different number painted on the outside), it should be recorded on the notes for the inspector's protection in the event of disputes. Usually the correct initials and numbers appear on both the sides and ends of the car, but in some instances the official initials of the car do not appear on the side. In such cases the initials should be recorded from the end of the car. Do not use the nickname of the railroad.

Recording Growers' Marks or Lot Numbers. When present, (214)
growers' marks, lot numbers, or packing house code numbers should be recorded next to each sample. This is usually done in the first column on the left of the notesheet. A record of the number of containers in each lot is desirable, even when all are the same grade. This information usually can be obtained from the warehouse or manifest, or the inspector may get an approximate estimate by observing the containers as they are loaded or coming off of the packing line. This enables the inspector to give proper weight to the lots when sampling and writing the notesheet and certificate. Samples from each lot or code number should be grouped together if practical for ease in computing percentages of defects and determining whether representative sampling has been achieved.

If there is significant irregularity between such lots (i.e. (215)
some pass, some fail), this information should be reported to the packing house representative or packing foreman. Since the meaning of many of these markings are not always obvious to the casual observer, no attempt should be made to report such results as separate lots unless specifically requested to do so by the applicant. If requested to report the lots separately, it is imperative that sufficient samples representative of each lot be examined to determine positively the grade of each individual lot and that an accurate count of each lot be obtained. Other markings such as brands, size, variety, grade, or Positive Lot Identification marks must always be reported as separate lots whenever there is a significant difference associated with such markings (see paragraphs 486 thru 490). ****

Two or More Products in a Car. If a car contains two or more (216)
products certified on one certificate, it is usually preferable to use a separate score sheet for each commodity rather than to crowd a single sheet. The rough draft should be written up on but one sheet. The separate sheets should be stapled together before filing.

Time of Scores on Note Sheets. When several trips are made to (217)
a car during the process of inspection and appreciable time has elapsed between trips, the scores made each time should be segregated either by drawing a line between them or bracketing the scores made on each trip.

-48-

To the left of the grower mark column for each group of entries should be recorded the time and date on which the samples were examined. Example: 9:00 A.M. - 10/6-, 2:00 P.M. - 10/6, 8:00 P.M. - 10/6-. This record is particularly important when the inspection of the car extends over more than one day. When one inspector starts an inspection and another completes it, the above procedure should be followed with the addition of placing the initials of each inspector opposite the group of samples each has inspected.

- (218) Score Sheets for Combination Grade or Unclassified Lots. Inspection of lots involving combination grades or lots where the proper grade markings must be determined, require slightly different procedure than for lots consisting of straight grades. In such instances, the samples should be sorted or classified into groups by grade (U.S. No. 1, U.S. No. 2 and defects of U.S. No. 2, etc). The amount in each group or grade should be entered in a column with a corresponding heading on the score sheet. The defects of the lowest grade should be entered under the customary column captions for that grade as on an ordinary score sheet. When the inspection is completed, the total of the defects and the percentage of each of the upper two or more grades should equal 100%. In some instances, it is desirable to record only the U.S. No. 1s and the defects of the U.S. No. 2. The percentage of U.S. No. 2 is determined by subtracting the total U.S. No. 1s and defects of U.S. No. 2 from 100%.
- (219) Recording Defects. Generally grade defects, undersize, etc. should always be recorded on the score sheet in figures representing weight or count as the grade may require. However, these figures may be supplemented by their equivalents in percentages, especially if the size of samples is irregular. When the grades, such as strawberries and turnip greens, provide for determining defects on a volume basis, they should be recorded in percentages. It is generally preferable to record fractional parts by the use of decimals. Such products as beans and peas and small containers of other products may be sampled and recorded in ounces in which case ounces should be used throughout. When samples are weighed in pounds, do not record fractions in ounces. When there can be any question as to the method of sampling, it should be indicated at the top of the columns on the score sheet, i.e. pounds, ounces, count.
- 220) If a score is entered on the notes and later the lot represented by this score is removed, draw a line through the score with a short explanation. Do not erase.
- 221) Recording Pack. With most products, the inspector has a chance to observe the tightness or filling of pack of all or most of the containers. He should, if practical, select his samples to be representative of the pack as well as other factors. Sometimes this is not practical and in such instances he should report the pack based on his observation of the true condition of the lot in this respect. The notes should explain differences between the sample scoring and the actual conditions reported, as: "Additional samples examined to determine pack only."

(222)

D E L E T E D

Misrepresentation on Score Sheets. All facts must be carefully (223)
 and accurately determined while the inspection is being made. Inspectors
 positively must not enter any score on the notesheet unless it accurately
 represents a sample that has been examined and scored by him. Instances
 have occurred, however, where inspectors have set down scorings of samples
 not actually taken to make it appear that a very thorough inspection was
 made. The filling out of a complete score sheet after inspections have
 been completed for the day when it is not possible for an inspector to
 remember in detail the scorings of the examined samples, even where
 there can be no doubt that a great many samples were actually examined,
 is a serious offense that may result in cancelling the license of the
 inspector. Such a score sheet is a misrepresentation of facts.

Giving Out Information from Score Sheets. The applicant is always * (224)
 * entitled to know the grade of the portion of the lot which has already *
 * been examined and may at any time be shown the scorings which have been *
 * recorded, with the understanding that they represent the lot at that *
 * time and does not guarantee the final grade. If such information is *
 * furnished the applicant before the inspection is complete, it is highly *
 * important that he be immediately informed when any later scorings in- *
 * dicate that the final report may show definitely different quality or *
 * different size than might be expected from the scorings already recorded.*
 * The score sheet should not be left where those who are not entitled to *
 * the information may read it. Prospective buyers are not entitled to *
 * such information until they have purchased the lot in question, unless *
 * the inspector is authorized by the applicant to give it to them. *
 * (See paragraph 62) Scales and measuring devices should not be used in *
 * a manner that will readily disclose the inspection results to those not *
 * entitled to such information. Carbon copies or other copies of the *
 * inspector's notesheet may be supplied to the applicant upon specific *
 * request and only with the approval of the Federal Supervisor. *

- 50 -

- (225) Where a grower, packing foreman or warehouse manager is inclined to be argumentive over lots which are found below grade, the inspector should, if possible, show him the actual defects taken from the samples and show him by means of the figures on the score sheet what must be removed in order to bring the lot within the tolerance.

ISSUING PRELIMINARY REPORTS

- (226) It is a common practice of shippers of some commodities to ask the inspector for a preliminary report to be used in wiring an offer to a prospective buyer or buyers. When handwritten certificates, such as FV-184, are used, preliminary reports are rarely necessary. The issuance of a preliminary report of this kind obligates the inspector to use care to see that this report is consistent with what will finally be included in the certificate since for practical purposes the certificate is issued when the preliminary report is given to the applicant.
- (227) An unrestricted preliminary report shall not be made until all usual samples for such a size lot of the particular commodity have been inspected from the finished packages and the "Products," "Size," "Pack," "Quality and Condition" and "Grade" statements written in final form on the note sheet.
- (228) Preliminary reports in use are generally one of two types. The type used in some states consists of a piece of pencil carbon and a sheet of plain paper placed beneath the note sheet before writing the pencil draft of the above headings. This carbon copy is furnished the applicant as his report.
- (229) In other areas Forms FV-204 and 206 "Preliminary Inspection Report" must be serially numbered. The original and 3 copies are prepared giving abbreviated information as to grade, etc. The original and one copy is given the applicant and the other copies are attached to the inspector's notes.
- (230) The procedures given above apply only to reports requested for use in making an offer of sale or for showing compliance with a contract of purchase and sale; they do not apply to reports furnished a grower or shipper for his own information, such as information on how his grade is being maintained during grading or packing operations or how his produce is keeping in storage.

REPORTING DELAYED LOADING

When a lot that has been inspected but held for later shipment is loaded, (usually not longer than one to two days later), the certificate will be issued carrying the car number and with the "Condition of Car" heading altered to read: "Condition of Car at completion of loading on _____." Oposite "Inspection begun." and "Inspection completed" shall be reported the actual starting and finishing hours and dates of the inspection and not the date of loading. The inspector must personally check the loading and car condition. (See paragraph 276). (231)

Should the applicant later advise that he will not ship the lot on which a preliminary report has been issued, or if advice as to shipment is not received from the applicant within a reasonable time, a certificate should be issued as of a lot in storage. The length of time which would be allowed to elapse before issuing such a certificate will depend on the commodity. The applicant should be advised of the necessity for issuing such certificates unless a loading date is given which is near enough so that the condition of the product will not have undergone material change. The date and time of inspection shown on the certificate should be that at which the actual inspection was made, and not the date at which the certificate was turned in to the office for typing, or the information was received from the applicant. (232)

INSPECTION COMPLETED ON A LATER DATE

Sometimes inspections are started on lots that are not completed until the next day or several days following the starting of inspection, due to slow packing operations, setting out and accumulating lots of specified sizes and grades or to holding over part cars. In such cases the inspector should make every effort to re-examine the previously inspected portions of the lot on the day of completion of inspection to bring the certificate up to date. The amount of time before such action is necessary varies with the commodity. The condition of lettuce, berries, new potatoes, etc. can change over night while apples and pears in storage, old potatoes, etc. will not usually show material change in from 2 to 5 days, depending on conditons. The time from starting to completion of inspection permissible without rechecking for condition factors should not be more than the product could be reasonably expected to hold without material changes. If the inspector is in doubt as to the length of time that is reasonable or encounters unusual circumstances, he should consult his supervisor. When such a lot is rechecked and brought up to date, the time of starting the inspection reported should be that at which the inspection was started on the date of completion of inspection. When factors are found to have changed since the first inspection was made, a line should be drawn through the notes covering that portion of the load and new entries made showing the facts as found at completion of inspection. The applicant or his agent should be advised immediately of such change. (233)

STATEMENTS SUPPLEMENTING CERTIFICATES

- (234) Inspectors are cautioned against making statements subsequent to the issuance of a certificate which report information not substantiated by the notes of the inspection. For example, where an inspection has been made to report condition or size only and scorings of grade factors were not made at the time of the inspection, the inspector should not at the request of a financially interested person make a statement either orally or in a letter as to his recollections of grade factors pertaining to the lot. The official information concerning a lot of produce which may properly be furnished an applicant or other financially interested person, can generally be stated fully in the certificate itself. In case of a request for information which definitely goes beyond the facts shown on the certificate or notes, the Federal Supervisor should be consulted before supplying such information.

CORRECTIONS OF INSPECTOR'S NOTES AND CERTIFICATES

- (235) Although the actual scorings must not be altered, inspectors very frequently make some changes in their computations or certificate drafts before they are turned in at the branch office. Also, these sheets are frequently reviewed by the inspector in charge or supervising inspector in the presence of the man who made the inspection, and changes are suggested which can be made at once.
- (236) When the inspector turns in his score sheet and draft of the certificate at the branch office, and is not present when this is reviewed by the inspector in charge or supervising inspector, it sometimes is necessary to make minor changes involving punctuation, spelling or grammar, in the interest of clarity with no actual changes being made in the facts covered by the certificate. Such changes may properly be made by the inspector in charge or by the supervising inspector with ordinary black pencil.
- (237) When the inspector has turned in his score sheet and draft of the certificate, and is not present when it is reviewed by the inspector in charge or supervising inspector before being typed, and an error is discovered involving percentages, grades, or statements of fact, the correction should be made with blue pencil and initialed by the party making such correction.
- (238) It will be noted that the last three paragraphs refer to corrections made before the certificate is typed. After the certificate has been typed and mailed, any changes which are made in the notes should be made in red and accompanied by a Notice of Correction, copies of such notice being attached to the branch office copy, State office copy, and Washington office copy of the certificate, along with the copies of the Corrected Certificate. (See paragraph 163).

In case the Washington office calls for the original score sheet (239) and draft of any certificate, any notations made on these at the time of forwarding should be made in red, indicating that they were not included on the sheet at the time the certificate was typed. Otherwise no alterations, corrections or additions should be made on note sheets transmitted to Washington.

PREPARATION OF THE LONGHAND DRAFT

The longhand draft of the certificate should be written with great (240) care, both as to accuracy and legibility. Special care should be taken as to legibility of all figures. Check it carefully before turning it in for typing. Particularly check for omissions and check numbers and percentages against the field notes. The longhand draft of the certificate may be subpoenaed for court use where it will be subject to close scrutiny by the attorneys of both sides.

The inspector should sign the longhand draft of the certificate in (241) the same way that he will sign the completed certificate. When he signs the draft of the certificate, the inspector is responsible for the accuracy of all statements appearing above his signature.

PREPARATION OF FV-184s AND SHORT OR TRUCK FORM CERTIFICATES

The certificate on the short form or truck form or FV-184 form is (242) prepared in longhand with three or five carbons. This should be written with even greater care than the longhand draft of the regular certificate, since it is given to the applicant at once and is not subject to later checking and correction before issuance. It is of great advantage in producing legible carbons to write this form on a clip-board or place a thin sheet of metal under the last copy of the set in order to have a hard surface upon which to write. Use ball point pens in writing handwritten certificates, if possible, otherwise use indelible pencils. Never use common lead pencils in writing these certificates.

Several types of handwritten certificates, FV-184, are being used (243) in many states. Supervisors should be certain that transient inspectors are familiar with the one in use in their respective state before they are given an assignment. Before writing the certificate, inspectors should check note sheets carefully and make certain they are complete and accurate. Before distributing copies, inspectors should check certificates for errors and be certain all copies are legible.

(244) COMMODITY INFORMATION THAT MUST BE REPORTED ON FV-184 CERTIFICATES

For all commodities all condition factors must be reported that affect grade. In addition, the following size and/or quality factors should be reported:

- Apples, Pears.....size range when not uniformly sized, color, firmness and general terms for shape.
- Asparagus.....color, diameter, length.
- Cabbage.....size, solidity.
- Carrots.....size, color.
- Celery.....count marked, midrib length, color.
- Cherries.....size range when not uniformly sized, condition of stems, color and firmness.
- Corn.....size, maturity, husk color.
- Grapes.....color.
- Lettuce.....solidity.
- Onions.....size and brightness; also shape when mixed shapes are encountered.
- Peaches, Plums, Prunes, Apricots.....size range when not uniformly sized, color, firmness.
- Potatoes.....size; skinning on new potatoes; cleanness on late crop potatoes; effective as notified.
- Tomatoes.....maturity.
- Watermelons.....size.

REPORTING ADDITIONAL INFORMATION ON FV-184 CERTIFICATES

(245) The instructions above indicate the minimum information that MUST be shown on handwritten FV-184 certificates.

(246) It is the policy of the inspection service to report any additional information that may be of benefit to the buyer or seller that reasonable utilization of space in handwriting permits if the information is within the limitations set by handbook instructions. It is suggested that supervisors contact the users of the service in his area to determine what information, in addition to the minimums required above, would make the certificate more valuable to them. Inspectors who receive requests to report additional information should refer them to their immediate supervisors. Additional information that might be requested could be in connection with "Pack" in cartons (mostly well, some fairly well filled), uniformity of sizing (fairly uniform sizing), protective material (pads - top and bottom of boxes), shape of potatoes (mostly well, some fairly well shaped), etc...

WORKSHEET INFORMATION FOR FV-184s

(247) The inspector must enter the Certificate Number in the upper right hand portion of the front of the note sheet and must sign his name where indicated.

The field notes on the inspector's note sheets must be neat and clearly legible so that duplicator copies may be made of them when necessary. The information present must be so full and complete that the Federal Supervisor will be able to prepare a complete typed certificate from them at any time up to five years after the inspection has been made. Information recorded must not be limited to the few items on the handwritten certificate but must be as detailed as it is for the preparation of a typed certificate. Included in the field notes must be grower's marks, if any, car or truck condition and a car or truck loading, columns to substantiate Size A or other statements on the certificate and other pertinent information. Be certain to show degree of filling in cartons or boxes such as, generally well filled, or as the facts may be. (248)

CORRECTING ERRORS ON FV-184 CERTIFICATES

If errors are made in car or truck numbers, percentage figures, in grade statements, or other errors that cannot be corrected neatly and legibly, the certificate must be voided and a new one issued. Refer to pars. 154 - 164. (249)

The original and all copies of VOIDED certificates must be returned to the office as instructed by the inspector's immediate supervisor. If an incorrect certificate has been issued, every effort should be made to have all copies of the incorrect certificate returned to the local office. (250)

Minor errors on handwritten certificates may be corrected by drawing a line through the error and writing in correct words only if all copies of the certificate are available. All such corrections must be initialed by the inspector. Avoid unsightly scratching or x x'ing out. Remember, certificates are legal documents. The quality of our inspections is often judged by the appearance of our certificates. (251)

PART III

THE CERTIFICATE

- (252) The material in this section provides standardized terms that have been adopted and defined by the Service for use in writing certificates. It is the responsibility of every inspector to become familiar with these terms and instructions accompanying them and to use them correctly. If the certificate is not correctly written, it loses value regardless of how well the inspection may have been made.

MODIFYING CERTIFICATE HEADINGS

- (253) The following certificate headings are arranged in the order that they occur on the regular typewritten Inspection Certificate, FV-47; Inspection Point; Car Initials and Number; Inspection Begun - Completed; Applicant; Shipper; Condition of Car; Products; Loading; Pack; Size; Quality and Condition; Grade; and Remarks. It is impossible to draw up a certificate form which is ideal for the certification of all of the large number of fresh fruits and vegetables which will be inspected and for all the different conditions under which the inspections will be made. The regular Inspection Certificate is suitable for most carlot inspections but at times it will be necessary to change or omit certain headings in order to fit conditions. Headings which are not suitable should be blocked out and replaced by the desired ones. Headings which are not used should be followed by x x xs to indicate that they were not overlooked.
- (254) As far as practicable, the instructions in this section also apply to handwritten FV-184 certificates. Exceptions from these instructions to make them adaptable to handwritten FV-184 certificates must be authorized by the inspectors' District Supervisor or Federal Supervisor.

CERTIFICATE NUMBER

- (255) Certificates are printed in sets of an original and several copies. Each set is serially numbered in an upper corner. All sets must be accounted for by number to the State office where they are subject to audit.

INSPECTION POINT

- (256) This is the name of the station, side track, switch or the address of the storage, warehouse, packing plant or grower's packing operation at which the inspection is made and should include the name of the state.

- 57 -

The name of the railroad must also be shown, if more than one serves the shipping point. When certificates cover consolidated lots from two or more inspection points, the words "See Remarks" should be shown after this heading and the various inspection points reported in a "Remarks" statement near the bottom of the certificate.

KIND OF CAR

Generally cars used for shipping fresh fruits and vegetables may be (257) classed as refrigerator, express refrigerator, baggage, box, insulated box, ventilated box and stock cars. If any special type of car is used, the special name may be given provided it is official with the railroad company, such as "Bunkerless Refrigerator Car," a new type of PFE, and "Fan Refrigerator". If a mechanical refrigerator type of car is encountered (such as a SIRX), a statement "Temperature controls in operation" or "Temperature controls not in operation" should be made, depending on the facts as determined by the presence of frost or heat being given off, the sound of motors running or other means. On fan refrigerators report whether the fan lever is in "on" or "off" position.

* "Form Covered Refrigerator Hopper Car". This descriptive term shall (257-a) *
 * be used for a new type of car which is basically a covered hopper car *
 * with three compartments. Each compartment has a full-length hatch at the *
 * top. The exterior is insulated with 2 inches of polyurethane foam. *

CAR INITIALS AND NUMBER

When inspections cover lots loaded into railroad cars, the car (258) initial and number will be the chief means of identification. It is vitally important that they be accurately recorded. (See paragraph 212).

The inspector should always make every effort to personally observe (259) the product loaded into the car so that he will be able to certify the car number, however, in some instances it will be impractical for the inspector to do this. In such cases, if the applicant can furnish the car number into which the lot has been, or will be loaded and wishes it to appear on the certificate, the inspector should show "See Remarks" in the "Car Initials and Number" heading. The car initials and numbers can then be reported on the authority of the applicant in a "Remarks" heading near the bottom of the certificate. Example: Applicant states above lot loaded (or to be loaded) into car PFE 12345.

LOTS NOT IDENTIFIED BY CAR NUMBERS

Lots not identified by car numbers can be divided into three classes (260) as follows:

- (261) Lots Identified by Truck Numbers. In cases where certificates are desired on truck loads, the truck or trailer license number should be shown on the certificate in the place provided for the car initial and number, blocking out the words "Car Initial" and typing in the words "Truck License", "Semi-trailer License" or "Trailer License". The number on the semi-trailer or trailer should be used in preference to the truck number when the load is not on the power unit of the truck as the truck-tractor is frequently changed enroute on long hauls.
- (262) Under the heading "Kind of Car" block out the word "car" and insert "Truck" or "Trailer." The kind should be reported as "Refrigerator," "Covered" or "Open".
- (263) In the inspection of produce shipped in refrigerator trucks or trailers, the same general policies should be followed as when making inspections in refrigerator cars. The word "Car" should be blocked out under the heading "Condition of Car" and the word "Truck" or "Trailer" inserted so that the heading will read "Condition of Truck" or "Condition of Trailer." Under this heading if there are bunkers, report the position of hatch covers and plugs, amount of ice, or whether the bunkers are empty. If it is mechanical refrigeration then report whether the refrigerator motor is running or not running. Also report the type of floor and any defective equipment such as loose fitting doors, defective roof, walls, etc. If the truck is not a refrigerated type, this heading should be followed by x x xs.
- (264) Whenever practical, the loading should be described in rows and layers, but it is not necessary to go into as much detail as on lots loaded in cars.
- (265) When the applicant requests that a large lot being loaded on two or more trucks be reported on one certificate, the truck license numbers should be reported under a "Remarks" heading and "See Remarks" should be shown in the space for car initials and numbers.
- (266) Piggy-back Trailers. When inspecting produce loaded in piggyback trailers, show on the certificate the number on the side or end of the trailer in place of the state license number. It is not necessary to show the number of the flat car on which the trailer is loaded. When the contents of two trailers on one flat car are certified, separate certificates should be issued for each trailer. The instructions in paragraphs 261 and 262 above for truck-trailers also apply to piggy-back trailers.

Lots Identified by State Lot or Other Stamps. On the regular certificate, when lots are not identified by car or truck numbers, the headings "Shipper, Car Initials and Number, Kind of Car and Loading" should not be blocked out but should be followed by three spaced x x xs to indicate that the headings have not been overlooked. If it is desirable for purposes of filing or recording, the heading "Car Initials and Number" may be blocked out and "Lot Inspection" or "State Lot Number" may be typed in its place, however, this does not eliminate the necessity of quoting the stamped number under the "Products" heading. Generally the heading "Condition of Car" should be blocked out and a new heading "Where Inspected" typed on the same line followed by a statement as to the location of the product at time of inspection. If this is not done, the heading should be followed by x x xs. (267)

While they are not as reliable for purposes of inspection as state lot stamps, warehouse lot numbers or other numbers stamped on each container for the purposes of establishing a lot distinguishable from all other stock in the same location may be used in a manner similar to state lot numbers, except when apples or pears are certified in storage with an Export Form Certificate, the container must be identified by either a State Lot Identification number or a public storage lot number. Private warehouse lot numbers are not acceptable for this purpose. Growers' marks or numbers, packing code numbers, etc. are not satisfactory for identification of storage lots. Such marks or numbers are generally found on other containers in the house in addition to these in the inspection lot. (268)

Lots With No Lot Identification. Frequently lots are inspected which cannot be identified by car or truck number and which are not stamped with a State-lot or other identifying number. The applicant should be advised that such lots cannot be identified with the certificate and it will have little or no value in settling disputes or in legal or P.A.C.A. actions. On this type of certificate unused headings should be followed by x x xs. It may be of value to the applicant to have the lot identified as to location as being in a certain section of a storage room. If this is possible, it should be typed in a "Where Inspected" heading after blocking out "Condition of Car." Example: Where Inspected: In applicant's cold storage plant, Room 3, Section C. (269)

INSPECTION BEGUN — COMPLETED

The date of the certificate is the date of completion of inspection. (270)

(271)

These headings are to be used in reporting the hour and date of starting and completion of inspection regardless of the time elapsed. (See Part II, paragraphs 231 to 232). Do not use figures on the certificates to indicate the month.

(272)* Record the exact local time on the certificate. No reference should be made
* as to standard or daylight saving time. *

(274) Examples:

INSPECTION BEGUN: 9:00 a.m., May 3, 1959. INSPECTION COMPLETED:
12 Noon, May 3, 1959.

INSPECTION BEGUN: 9:30 a.m. May 4, 1959. INSPECTION COMPLETED:
12 Mdt. May 5, 1959.

(275) On certificate forms where no "Inspection Begun" heading is supplied, the heading should be typed in just above the "Car Equipment and Condition" heading.

(276) Where there is an interval of one or more days between the time of completion of inspection and the time of loading the lot, the heading "Condition of Car" should be followed by the words "at completion of loading" and the date of loading. Example:

Condition of car at completion of loading June 2, 1959: Hatch covers closed, plugs in, bunkers empty.

(277) Truck Lot Certificates Other Than FV-184 carry the "hour" for recording the time of completion of inspection only. As the use for which this form is designed does not usually require more than about 4 hours, the hour of completion of inspection is sufficient. Should any inspection reported on this form be prolonged beyond 4 hours for any reason, both the hour of beginning and of completion of inspection should be shown by writing in the necessary headings.

APPLICANT

(278) The certificate is to be issued to the party making the application, whether this be the grower, shipper, consignee, broker or carrier. In the case of requests from a carrier, the carrying company should be shown as the applicant, represented by the agent making the application. Thus: Union Pacific Railroad Company, John Doe, Agent. Include the name of the state in any address.

SHIPPER

The shipper is the party actually shipping the lot. The address of (279) the shipper to be shown is his post office address, which is often not the shipping point. If the shipper and the applicant are the same, the word "Same" may be shown in this heading. Be sure the name of the applicant and shipper are correctly spelled and stated. Do not write "Reddington Fruit Company" if the correct firm title is "Reddington Fruit, Inc." Do not use nicknames such as "Jim" or "Jack" in showing an individual or firm unless such nickname has been adopted as part of the business name.

CONDITION OF CAR

Definition of Terms. The following terms should be used in describing the condition of the car. The definitions given below show the meaning of the terms as understood by the trade and the carriers: (280)

B End: The end of the car on which the hand brake wheel or lever is located. (281)

A End: The end of the car opposite the B end. (282)

"R" Side or Right Side: The side of the car to the right of the observer when standing inside of the car and facing the A End. (283)

"L" Side or Left Side: The side of the car to the left of the observer when standing inside of the car and facing the A End. (284)

Bunkers: The ice compartments of a refrigerator car or truck. (285)

Tanks: The ice tanks of some lines of refrigerator cars. (286)

Bunker Bulkheads: The partitions between the bunkers and the main part of the car. (287)

Collapsible Bunkers: Bunker bulkheads that may be folded or pushed back, thereby extending the available loading length of the car. Example: "Hatch covers closed, plugs in, ice bunkers collapsed". (288)

Hatches: The openings in tops of bunkers. (289)

Hatch Covers: The lids covering the hatches of refrigerator cars. Hatch covers are "closed" or "open" or "thrown back." The greatest possible degree to which this type of cover can be supported is 34 degrees, which should be reported as "open." If hatch covers are raised only slightly, it is best to report the amount of raise in inches: "Hatch covers raised 3 inches". (290)

(291) Plugs: These furnish an insulated closing of the hatches under the cover. On many makes of cars they are attached to the hatch covers but on others they are separate. "Plugs in" or "Plugs out" usually is sufficient to describe their placement. With some SFRD cars "Bars indicate plugs closed" or "Bars indicate plugs open" applies. If the plug is held open by the plug chain, ordinarily remedy this situation and report as "in".

(292) Amount of Ice: Ice bunkers are commonly 6-1/2 feet deep from grating to top. When there is no ice or heaters in the bunkers, they will be reported as "bunkers empty." When they are approximately half full of ice or less, state the number of feet of ice in the bunkers, as "approximately 2 feet of ice in bunkers," or "few small chunks in bottom of bunkers". When bunkers are more than half full of ice, show the amount in reference to the space above, as "ice 2 feet from top of bunkers." Do not attempt to estimate in less than 1/2 foot variations. When bunkers are full of ice, they should be reported as "bunkers full of ice" unless "half stage icing" is used. In some refrigerator cars, a removable grate separates the upper and lower halves of the bunkers. When only the upper half is filled with ice, this is known as "half stage icing" and should be so reported. In some deals many shipments are made with half stage icing and it is impractical for the inspector to tell them from fully iced cars at time of inspection. In these instances, the term "ice to top of bunkers" should be used instead of "bunkers full of ice."

- Examples: (1) Hatch covers closed, plugs in, bunkers full of ice.
(2) Hatch covers closed, plugs in, ice to top of bunkers.
(3) Half stage icing, hatch covers closed, plugs in, ice to top of bunkers.

(293) Drain Pipes, Drains, Traps: These devices are for carrying waste water from bunker pans. Traps are coverings of the upper or lower openings of drain pipes. If the car may pass through low temperatures, show the drain pipes to be "open" or "closed by traps" or "plugged"(with paper, straw and the like). At other times the drain pipes need not be noted.

(294) Floor Racks: This term applies to the raised slatted floor above the true floor of a refrigerator car. It is standard equipment and therefore need not be shown as present, unless requested by a party interested in the shipment. If there are no floor racks, state "no floor racks." For bulk loads floor racks may be "raised against sides of car."

(295) Ribbed Floor: This term refers to the strips nailed lengthwise to the true floor of some old line refrigerator cars. State "ribbed floor" if present.

False Floor, False Walls: These terms apply to false solid floor and walls built a few inches from true floor and walls as a protection against freezing. Show the number of inches from true floor and from true walls to face of false walls and floor. Example: "False floor, top 6 inches above true floor, false walls ends and sides of car to doors, face 6 inches from true walls." (295)

Paper Lining: Paper lining is often applied as a precaution against freezing. Show which portions of the car are "paper lined" (or "double papered" if two thicknesses are used); whether it is floor racks, false floor or true floor that are papered; whether the sidewalls, bunker bulkheads or all walls are papered; and height to which paper extends on walls, thus: "True floor papered, floor racks double papered, all walls, including doors papered to within approximately 2 feet of ceiling" or walls may be papered to "height of doors" or to "height of load," or "to ceiling" or more frequently perhaps "to height of approximately 3 feet." Sometimes it may be "true floors papered, paper brought up side walls approximately 2 feet." Sometimes it is simply "bunker bulkheads papered," or "opening in bunker bulkheads papered." (297)

Pads and Straw, Hay or Shredded Paper Bedding: These products are used as protection against bruising or freezing in unpacked products such as watermelons and squash or products in sacks such as potatoes and onions. Excelsior, fiber shredded paper either loose or in pads, are sometimes used on the floors and side walls of cars to prevent bruising in the floor and side wall sacks of such products as potatoes and onions. Thus: "Floor and end walls covered with excelsior pads to height of load" or "Floor covered with shredded paper." Conditions may make it desirable to show the thickness of such protective material. The presence or absence of floor pads may have an important bearing on damage claims due to bruising in floor layer packages. As complete information as possible should be reported when pads are used. Trade names for pads such as "Jiffy" should not be used. (298)

Examples: (1) "Macerated paper pads on floor racks beneath most bottom layer sacks, none under some sacks."

(2) "Cotton pads on floor racks."

Heaters: Cars which are to move under any type of heater service usually carry "Heated Car" cards on a door on each side of the car. In such cases it is unnecessary to make any reference to the presence of heaters, their type and whether "burning" or "not lighted." It is sufficient, in addition to the usual information to state "Car carded for heater service." If cars are not carded and examination shows heaters in bunkers, this fact should be stated, including whether or not burning. (299)

- (300) Doorway: The space enclosed by the door casing.
- (301) Space Between Doors: The space in the car between the doorway on each side. Products should not be reported as being in doorway when what is meant is that the product is in the "space between doors."
- (302) Doorways Boarded Across or Boards Across Doorway: These terms are to be used to describe doorway protection of bulk loads when the car is loaded full length. Show the height either in number of feet or "to height of load."
- (303) Doorways Slatted: This term applies to slats across doorways for retaining the bulk or package load. Show how high the slatting extends.
- (304) Wall Openings Slatted: This term applies to the use of slats to close the openings in the walls of stock cars loaded with watermelons. Slatting usually extends to height of load.
- (305) Vents: Openings in the ends of cars for the purpose of ventilation are called vents. They may be "opened" or "closed." If one or more are in each condition, show this and the respective locations. Thus: "Upper vent open, lower vent closed, each end of car."
- (306) Ventilating Doors, Slat Doors, Screen Doors: These are doors of ventilated box cars provided with slats (or bars), or screens or both to furnish ventilation. (See example next paragraph).
- (307) Solid doors or any of the various kinds of ventilating doors may close the doorways of ventilated box cars. Either the solid or the ventilating doors may be "in position over doorway" or the condition may be "doorways closed, half by solid doors, half by ventilating doors." "Doors cleated open _____ inches" may be stated of doors of box cars giving the number of inches. The open space is for ventilation. It may be necessary to add such a statement as "Bottom 2 feet of space boarded up."
- (308) Defective Equipment. Defective car equipment should be called to the attention of the shipper immediately upon its being noticed so that steps to repair or replace the car may be taken before loading progresses further.

If inspected produce is loaded in defective cars, the defects should be described on the certificate. Statements in this connection should refer only to defects which are of sufficient importance to have a possible bearing on the condition of the product. If plugs and doors do not fit, the width of the space at one or more sides is to be stated. Leaks in the roof, loosened siding and roof sheathing, displacement of the bunker bulkheads, holes in the floor, contamination of the floor by grease, chemicals such as salt or other materials, and any other damage to the car that may have a bearing upon the condition of the shipment are to be shown. It is important that the description of defective equipment be exact and be so worded that it cannot be used improperly for claims purposes.

PRODUCTS

The primary purpose of the "Products" heading on the certificate is (309) to identify the lot. Under this heading the following identifying factors are to be reported when appropriate:

1. Name of product or products inspected.
2. Variety when known; if not, the type or description.
3. Container, type or kind.
4. Brands.
5. Grower's marks or lot numbers.
6. Grades and sizes.
7. Lot numbers and stencils.
8. Identification by comparison terms.
9. Quantity in lot covered by the certificate.

Name of Product. This should be the first item shown under the (310) "Products" heading or should be preceded only by the name of the variety, type or description. On the typed certificate the product should be in capital letters.

Variety, Type or Description. The variety is to be stated if known (311) with certainty and has any bearing on the commercial value of the product; otherwise, when pertinent, such expressions as the following should be used: "Round white POTATOES," "White fleshed PEACHES," "Yellow ONIONS," "Golden type CELERY." Where the inspector is uncertain of the variety or strain but the containers are stamped with a variety, it may be quoted, thus: "APPLES in boxes stamped Starking Delicious." If the inspector is certain the variety marked on the container is incorrect, he should report this fact as in the example following: "Anjou PEARS in boxes stamped "Comice." When the inspector has seen the product washed, brushed, waxed, etc., he may report it on the certificate. This should be done preceding the name of the product and variety. Example: "Washed long white POTATOES," "Brushed Elberta PEACHES," "Waxed TOMATOES."

- (312) Containers, Type or Kind. Where containers are of the standard types such as are commonly used for the product, it generally is not necessary to describe them further than to state the types such as "wire-bound crate," "tub-type bushel basket," "burlap sacks," etc. Where products are shipped in unusual containers or in variations of a common type of container, a description is necessary. Do not use trade names such as "Saxoline," "Bruce Box," "Howard Crate," etc.
- (313) If noticeable used, dirty or weatherstained containers are used, they should be mentioned as "POTATOES in used, turned sacks," "APPLES in unlidged weatherstained boxes."
- (314) The net weight stamped, marked or printed on the containers should be quoted on the certificate when it is of value in indicating the size of commonly variable size containers, such as in the case of sacks. Example: "-----printed '100 lbs. net.'"
- (315) Cell and Tray Packs. Products packed in containers with egg crate type dividers should be reported as "cell type cartons." Products packed in containers with pressed trays made with molded cups between layers should be described as "tray packed boxes" (or cartons).
- (316) Consumer Size Packages. When inspecting consumer size packages, such as small cartons or sacks, shipped in master containers, report the count for the lot as the number of master containers. The number of units in each master container should be stated as in the following examples:
- (1) TOMATOES, manifested as 300 shipping cases containing 12 window cartons labeled "Fenway Farms."
 - (2) Netted Gem POTATOES in cotton net sacks; branded "Rose Best, 10 lbs. net, U. S. No. 1" packed 6 to a paper shipping sack printed "Rose Best." Applicant's count 400 shipping sacks.

Use the term "multiwalled master containers" under the "Products" heading when the container meets this classification.

- (317) Cellophane, Pliofilm and similar terms are trade names applied to a type of transparent material used as wraps, liners, bags, etc. These terms are not to be used on the certificate. To describe material of this kind, the term "film" should be used, as "film bags," "film wrapped".
- (317a)* Foam Containers. Although this is a trade term, "foam containers" *
* should be used to describe all types of molded plastic foam containers *
* (expanded polystyrene is the proper technical term). This container *
* is new to the produce industry and is becoming increasingly popular. *

Brands. A brand is an insignia, picture, or wording that is labeled. (318) printed or stamped on a container and is used as a trade mark by the shipper for purposes of advertising. The identifying words in the brand should be shown in capital letters, or in quotation marks, under the "Products" heading on the certificate. Example: "labeled WHITE ROSE," If such wording is lacking, a brief description of the insignia or picture is necessary. Sacks, and occasionally other containers, may be printed or labeled with some general design or stock wording which will be appropriate for a particular production region, as: "Idaho Onions." These are not brands and containers so marked should be referred to as "printed" or "stamped" with the wording carried. When the containers bear no labels or brands, this fact should be stated if the lot certified customarily would have such identification so that those reading the certificate will know that it was not overlooked. Example: "Boxes not labeled," "Sacks not branded or marked."

Federal Regulations require that old brands and labels be removed (319) or marked out and the necessary new marking added by tag, label or other approved means. If this is not done, a statement of facts should be included under this heading. Example:

Products: Cobbler POTATOES in used sacks showing various brands and tagged "J. Jones & Son, Foley, Ala., 100 lbs. net."

If a brand is misleading as to the commodity it covers, it should (320) be described in detail. The labels on lugs of grapes carrying the picture of a large red tomato with a brand name, is an example in point.

It is not necessary to quote or show the state of origin or shipper's (321) name on the brands or labels. This information is indicated in the upper portions of the certificates.

Growers' Marks and Lot Numbers. Unless they take up excessive (322) space or the certificate is crowded for space, three or less growers' lots numbers or marks should be mentioned under the "Products" heading; if more are present, the term "various growers' marks" or "lots" may be used. The applicant sometimes alters the loading after completion of inspection and may either intentionally or otherwise add off-grade lots not covered by the inspection. For this reason, mention of growers' marks may serve as a protection to the shipping point inspector in case of re-inspections in the market. Growers' marks and lot numbers on containers examined should always be recorded on the note sheets regardless of the number.

- (323) Grades and Sizes. When the grades and sizes are printed, stamped or marked on the container, they should be quoted under "Products" on the certificate. When the inspector secures his information as to sizes second hand, he should state "manifest shows" or "applicant states sizes 100s to 163s," etc. If the inspector secures the range of sizes from the packages by observation, he should so state, thus: "120s to 193s noted" or "5 x 6s and 6 x 6s noted."
- (324) State Lot, Storage Lot or Other Lot Numbers and Stencils. State lot, storage lot and similar identifying numbers stamped or permanently attached to each container in the inspection lot, should be quoted under the "Products" heading regardless of reference to them under the "Car Initials and Numbers" heading. If storage lot numbers or other similar numbers are not stamped or attached to the individual packages but are merely tagged or marked on the front of a warehouse pile, they should not be mentioned under "Products" but may be reported under a "Remarks" heading.
- (325) Examples: Remarks: "Warehouse pile tagged lot A-173" or
"Warehouse records show lot stored under number A-173."
- (326) On government and similar purchases, the Purchase Order number should be quoted under the "Products" heading when it is marked or stenciled on the containers. If it is not on the containers, it may be reported under a "Remarks" heading, thus: Remarks: "Applicant states above lot covered by Purchase Order OAK-2456."
- (327) Containers in overseas export shipments are usually stenciled or tagged with shipping symbols in the form of a series of initial letters, numerals and port marks. These should be quoted exactly as they appear on the containers for such markings must agree with the requirements in the exporter's letter of credit. All letters in these marks should be in capitals. When a portion of the markings is above or "over" other portions, this can be indicated by a diagonal bar when quoting. Example: "QTC-1293/MANILA."
- (328) Identification by Comparison Terms. In some cases cars are loaded, or warehouse and truck lots set up, that contain two or more grades that cannot be identified by the usual methods, such as marks, brands, containers, etc. In these instances, separate identification can be established by location in the car or by means of general comparison terms such as "larger size" and "smaller size."

Example:

PRODUCTS: Yellow ONIONS in new open mesh sacks printed "Red Star, (329)
50 lbs. net." Manifested as 200 sacks larger size
onions in A end of car nearest bunker; 400 sacks smaller
size onions remainder of load.

SIZE: Larger size onions generally 3 to 4 inches in diameter.
Smaller size onions generally 2 to 3 inches in diameter.
Undersize each lot within tolerance.

GRADE: Larger size onions: U. S. No. 1, 3 inches minimum.
Smaller size onions: U. S. No. 1, 2 inches minimum.

Do not use terms like "large onions" or "small onions" as they may be (330)
misunderstood to be size classifications.

Quantity Certified. The number of packages covered by the inspection (331)
should always be reported on the certificate. It is preferred that the
statement as to count be made at the end of the "Products" statement.
However, in some western states it has been the custom for many years to
report the count after the name of the commodity. There is no serious
objection to this procedure where it is an established custom. Generally
the count of lots loaded into cars will be made on the authority of some
one other than the inspector, such as "applicant's count," "loader's
count," "manifest shows," etc. On bulk loads the car, truck or bin is
the container. The net weight should be supplied by the applicant and
quoted on his authority or from certified scale receipts. (See paragraph
402).

On warehouse, storage and similar lots the inspector should state (332)
the count on his own authority if the size, location and arrangement of
the lot permits accurate counting, thus: "300 boxes noted." If an
accurate count is impractical, the inspector may quote the manifest or
checker's count but should always make an approximate count to be sure
that substantially the number of packages stated is being offered for
inspection.

If the carlot or warehouse lot consists of more than one product, (333)
the number of packages of each product should be reported.

If the load consists of 2 or more varieties, grades, brands or (334)
growers' lots of the same commodity, the number of packages of each may
be reported if requested by the applicant and an accurate manifest is
available. If a few odd identifiable packages are found, the number
should be reported so that undue weight will not be given them. Some
shippers have requested that the number of packages in each lot in mixed
loads be omitted from certificates as the inspector usually obtains the
count from the first figures of the checker which may later be changed if
found incorrect.

(335) When an inspection is made of a fully loaded car and the certificate is restricted to an accessible portion of the load such as the "upper 3 layers," the count reported should be that of the entire load.

(336) If the certificate is restricted to an identifiable lot in the load such as product, brand, grade, specified stacks, etc., the count to be reported is that of the number of containers in the portion or lot to which the certificate is restricted. (See paragraphs 574-586). An example is given below of a load which contains 2 products, only one of which is certified. The same principle would apply if it were two varieties, grades or brands. Example:

Products: Netted Gem POTATOES in new burlap sacks, "Rose Brand, 100 lbs. net." 200 sacks noted. See "Remarks."

Loading: Through load, potatoes 3 rows, 5 layers, remainder of load onions in sacks, 4 rows, 6 layers. See "Remarks".

Remarks: Inspection and certificate restricted to potatoes only.

(337) Examples of Products Statements:

(1) Katahdin-Chinpeva type POTATOES in new burlap sacks branded "Maine Beauty, 100 lbs. net, U. S. No. 1" Checker's count 300 sacks.

(2) Sweet PEPPERS in tub-type bushel baskets; lids stamped "California Wonder, U. S. No. 1; " labels under lids GOLDEN GIRL BRAND. Loader's count 720 baskets.

(3) Yellow globe ONIONS in new papernet sacks printed with 3 overlapping hearts. Applicant's count 300 sacks printed "50 lbs. net," 600 sacks "25 lbs. net." Each sack tagged "ROD -2368410N."

(4) APPLES: Applicant's count 798 tray packed cartons labeled "Blue Ribbon Brand" and stamped "Fancy, Starking Delicious," and with grower's lot numbers 52869 and 96A732. Sizes 13⁸s to 16³s noted. Each box stamped "Wash. Dept. of Agri. - 90-004-Lot Identification."

(5) Washed Pascal type CELERY: Loader's count 378 wirebound crates, labeled "BEST YET BRAND." 1-1/2 to 3-1/2 dozen count marked on crates. Stamped "Fed-State-Lot 142-66."

(6) Mixed vegetables: Manifested as 100 waxed paper lined crates LETTUCE, 100 paper lined crates bunched CARROTS, 299 wirebound crates of washed Pascal CELERY. Each crate labeled "Fine Eating Brand" and marked with count (4 to 5 dozen noted).

LOADING

Under this heading the method and arrangement of the load should be described. The loading description is not intended to be an exact counter check on the manifest as stated under "Products." When the loading is fairly regular and easily checked, the exact number of rows, layers and stacks may be stated. Extreme care must be used when a loading description certifies the number of rows, layers and stacks for the inspector is in fact certifying the number of packages in the car. (338)

Ordinarily it will be satisfactory to show only the number of rows and layers; whether the load is a "through" or "divided" load; center bracing; and the method and amount and manner of stripping. (339)

If the inspector sees the car center braced, he should state "Center braced." If the center bracing is not in when the inspector leaves the car, he should report: "Center bracing not in at completion of inspection." (340)

Do not make a statement such as "Load in good order." A statement of this kind is interpreted by railroad claim agents to mean that each package is in proper place, that all cross stripping is properly placed and nailed, that the center bracing is of proper strength and that the load is tight so that no end or side movement is possible. Obviously an inspector who sees a car only at certain intervals during the process of loading, is not in a position to certify to all of these points. (341)

Wiring or Strapping. When containers have been wired or strapped for export or for other reasons at time of inspection, this fact should be stated under the "Loading" heading, thus: "Boxes strapped each end" or "Crates wired each end and center." (342)

Condition of Packages. Broken, torn, badly stained or dirty packages should be called to the attention of the loading foreman and if broken or torn packages are not removed, they should be reported under this heading. Example: "Three sacks noted badly torn with contents spilling." Badly stained or dirty packages are reported under the Products heading. (343)

Warehouse and Storage Lots. Lots certified in warehouses, storages and similar locations are not loaded and this heading should be followed by x x xs unless it is necessary to describe the condition of the packages or to report strapping. (344)

- (345) Standard Terms for Describing Loading and Bracing of Cars. Most of the following definitions and Plates I to IX, which will be found at the end of this Handbook, are taken from the "Dictionary of Standard Terms for Use in Describing Loading and Bracing Methods of Fresh Fruits and Vegetables" published by the Freight Container Bureau of the American Railway Association. The use of these terms will do much towards promoting uniformity in the preparation of certificates and give a clear description of the condition of the load.
- (346) Layer: A course or stratum of the load, parallel to the floor of the car and one container in height. Plate I.
- (347) Stack: A pile of containers extending from one side of the car to the other, parallel to the end of the car and one container in length. Plate I.
- (348) Row: A pile of containers extending lengthwise of the car, parallel to the sides of the car and one container in width. Plate I.
- (349) First Layer: (Bottom Layer). The containers resting on the floor or floor racks of the car. Plate I.
- (350) Second Layer: The second layer counting from the floor. Plate I.
- (351) Stack Numbering. The stacks in the car are numbered consecutively from each end of the car toward the doorway. The stack adjacent to the bunker is numbered one, the next two, etc.
- (352) Incomplete Layer. A layer, usually the top layer, in which there is a smaller number of containers than in the full layers. Plate IX.
- (353) Guide Row. (line) A row of containers consisting of those that form only one layer of a row (or one row in a layer) usually placed first in a car when loading is begun, for the purpose of ascertaining the number of stacks which can be loaded and the amount of space which will remain. Plate II.
- (354) Through Load. A load in which no space is left between doors, the containers being loaded from end to end of car. There may be space fillers consisting of End Gates, End Braces, End Bulkheads, Spacing Strip and Spacing Frames. Plate II.
- (355) Divided Load. A load that is separated into two units at the doorways by center bracing, center gates or center bulkheads. If the load is not to be center braced or bulkheaded, it is not a divided load. Such undivided loads should be described as illustrated in the following example: "Loaded in each end of car, sacks 6 layers, 6 rows. Space open between doors." Plate II.

Lengthwise Loading. Where the containers are arranged with the (356)
ends towards the end of the car. Plate III.

Crosswise Loading. Where the containers are arranged with the (357)
ends facing the sides of the car. Plate III.

Upright Loading. The arrangement of containers with the ends (358)
of the containers toward the floor and ceiling of the car. Plate III.

End to End Offset Load. A load in which the containers, par- (359)
ticularly baskets and climax baskets are arranged in rows so that each
container (except those in the first layer) is offset and rests equally
on two containers beneath. To use this method, the loading progresses by
rows from one end of the car to the other end. Thus: "Through load, end
to end offset, 6 rows, 4 layers." This is the most common loading for
bushel baskets. Plate IV.

Crosswise Offset. The arrangement of containers, particularly (360)
baskets, in stacks so that each container except those in the first layer
is offset and rests equally on two containers beneath. Thus: "Through
load, 5-4 crosswise offset, 4 layers." Plate IV.

Inverted V or Ellis Method. In this the lug-type containers (361)
are loaded crosswise and no horizontal strips are used. Inverted V spacing
frames of 2 x 3 material are placed in upright positions between the wall
of lugs and each sidewall and usually on each side of the center row of
containers. These frames are joined at their tips by corrugated fasteners.
Each arm of the V is diagonally in contact with the ends of one stack of
containers and prevents them from getting out of alignment..

Side Stripped Load. Another load occasionally used is known (362)
as "the side stripped load." Strips are nailed to sides of lugs without
any uprights. Describe as "Strips nailed to sides of lugs, no uprights."

Alternately Inverted. The arrangement of containers, partic- (363)
ularly hampers and baskets, in which half are placed with tops up and half
with tops down. In each row and stack adjacent containers are placed in
opposite positions and containers in adjacent layers are placed top to
top and bottom to bottom. Plate IV.

Side Load, Alternately Reversed. The arrangement of containers, (364)
particularly hampers, in which each container is placed on its side
lengthwise of the car and adjacent containers are placed with covers
facing to opposite ends of the car. Plate IV.

- (365) Tunnel Load. A load in which the containers are so arranged that in one or more of the middle layers some of the containers are omitted, leaving channels lengthwise of the car in which cakes of ice are sometimes placed.
- (366) On Bilge. The loading of barrels on their bilge with the heads of the barrels either toward the side or the end of the car. It is generally not necessary to mention this with double headed barrels, but it is important to show "on bilge" if the barrels have cloth tops or are made of veneer. Plate V.
- (367) On Edge. Describes loading of flat packages when on edge. (Not necessary to state if this is the customary loading, but should be mentioned if some in car are loaded flat and some on edge or if it is not the customary loading).
- (368) Diagonal Row. The arrangement of containers, particularly climax baskets, in the last row loaded, so that each container is at an angle to the containers already loaded. This arrangement is used to fill the crosswise space, if any, when the load is being completed.
- (369) Staggered Row. The arrangement of containers, particularly bushel and half bushel baskets, in the last row loaded, so that the remaining crosswise space is filled by alternately placing one basket against the load and the next against the car wall. Thus: "6 rows, one at one side of car staggered."
- (370) Deck Load. A load in which some of the containers are supported upon a deck built into the car.
- (371) Loose Load. A load which does not fit the car tightly lengthwise, even though some space fillers may have been used. Any noticeable loose loading should be described.
- (372) Lengthwise Space. The difference between the inside length of the car and the length of the load. Plate V.
- (373) Crosswise Space. The difference between the inside width of the car and the total width of the load of containers. Plate VI.
- (374) Rows Spaced. Describes the loading when approximately uniform amounts of space are left between rows and between outside rows and side walls to permit air circulation through the load.

Space at Sides. Describes a load in which the containers (375) are stacked in rows with no space between rows to permit as much space as possible left between the side walls and outside rows. This load is frequently used during cold weather to reduce freezing through side walls. The space is sometimes filled with insulating material.

Slack. The portion of space not taken up with space (376) fillers. Plate V.

Crosswise Slack. The amount of possible crosswise motion of (377) the load. It is usually due to the containers not completely filling the width of the car, or if it is stripped, to the car strips not butting against both car walls or not being nailed to the containers.

Space Filler. These are structures, frames or strips used (378) to fill the lengthwise space in the car. They are designated according to type as center gates, center bracing, center bulkheads, end gates, end braces, end bulkheads, spacing strips and spacing frames. Plate VIII.

Center Brace, Center Gate, Center Bulkhead. The structure (379) placed between the two parts of a divided load, in the space between doors, to keep the load in the two ends of the car from shifting towards each other into this space. Plate VII.

End Gate, End Brace, End Bulkhead. The structure placed at (380) the end of the car to fill all or part of the lengthwise space in a "through load." Plate VIII.

Spacing Frame. A structure built of car strips or of boards (381) and placed between adjacent stacks to fill part or all of the space in a "through load." Plate VIII.

Spacing Strips. The strips or boards placed between (382) adjacent stacks to fill part of all of the space in a "through load." Plate VIII.

Car Strips. The strips of wood or lath used on containers, (383) usually for the purpose of preventing the containers from shifting crosswise of the car. All or any certain layers may be stripped. Stripping may be reported as "nailed" or "not nailed", however, statements as to nailing must be restricted to the portions of the load which the inspector has been able to observe. Packages are "single stripped" when only one strip is used on a single layer of a stack and "double stripped" when two strips are used. When the stripping is not that customarily used, or when the packages are fragile, it may be desirable to show whether single or double stripping is used. Plate VIII.

- (384) Vertical Stripping. Vertical stripping is used in some shipments of western grapes, deciduous fruits and tomatoes. Two principal methods are used: (1) Strips placed at the corners of the containers, known to the trade as the "Hoak Load." (2) Strips placed in the center of the ends of the containers, known to the trade as the "Lindley Load." In both cases the strips usually extend well above the top of the load. These methods should be reported as: (1) "Vertical strips at corners of lugs." (2) "Vertical strips at ends of lugs."
- (385) Incomplete Layer Brace. A structure built so as to hold in position against shifting an incomplete layer of containers. Plate IX.
- (386) Step-Up Brace. A type of incomplete layer brace that raises one or more layers of containers in a stack so that the raised containers brace the incomplete layer against shifting. Plate IX.
- (387) Bulk Load. If the product is in bulk, such as cabbage and potatoes, the approximate depth of the load should be shown and whether loaded entire length of car or in the ends with a slatted or solid bulkhead retaining the load at the doorways, or if the load is divided into bins. Examples:
(1) "Bulk, through load, 4 to 5 feet deep, doorways boarded to height of load."
(2) "Bulk, divided load, 3 to 5 feet deep, bulkheads braced."
- (388) V-Type Bulkheads. These bulkheads are first placed loose in ends of car and moved forward as the loading progresses, until they meet in the center. Example: "Divided load, approximately 4 feet deep. B end divided by bulkhead at 1/2 length; V-type bulkheads between doors. Bulkheads 4-1/2 feet high and braced to ceiling."
- (389) A-Type Ventilator. The triangular slat ventilator placed lengthwise on the floor in many cars of bulk cabbage. Example: "Through load, 4 to 5 feet deep. A-type slat ventilator through center, approximately 2-1/2 feet spread, 2 feet height. Doors boarded to height of load."
- (390) Top Ice or Ice Over Load. Ice over the top of the load should be reported under the "Loading" heading of the certificate in all cases.
- (391) Top ice may consist of chunk ice or crushed ice, which is distributed over the top of the load. The depth of top ice may be stated approximately in inches or feet.

The term "snow ice" is rather commonly used in some parts of the country to describe the very finely crushed or shaved ice used in packages or blown over the tops of loads. Practices as to the fineness to which it is crushed are so variable it is not believed practicable to attempt to make distinction between "snow" and "crushed ice". The term "crushed ice" should be used to describe both types of ice. (392)

Reporting Loading in Mixed Cars or Trucks. When several certificates are issued on different products in a mixed car, the arrangement of the load should be described on only one of the certificates. Under this heading on the other certificates the following notation should be made: "See certificate (number)". These certificates should be linked together by proper cross reference under a "Remarks" heading. (393)

* Describing Palletized Loads. Describe the loading of the pallets and the number of rows and layers of containers on the individual pallets. For example, "Through Load, 2 pallets wide; 3 rows, 16 layers on pallets". This very abbreviated description is the minimum to be reported. More detailed information may be reported such as the number of containers per layer if desirable. (393a) *

REPORTING RANGE AND AVERAGE PERCENTAGES

(A) Averages. (394)

Average percentage of grade defects, off-size and decay shall be reported to the nearest whole number (par. 422). Statements dealing with average percentages must be based on sufficient samples believed by the inspector to be representative of the lot.

Average percentages of defects, off-size, decay and other factors are often not sufficient to give a true picture of irregular conditions that may exist in commercial shipments of fruits and vegetables. The irregular conditions in these factors, which are found in inspections, makes it necessary to establish a definite policy in reporting ranges. (395)

(B) Ranges. (396)

A range reports the lowest and highest percentages of a factor that has been found in the samples examined during the inspection procedure. When a lot is below grade, either because the average exceeds the grade tolerance or because individual containers exceed the container tolerance, the range as well as the average percentage must be reported regardless of the length of the range (see par. 502). On factors where no tolerance is involved, a range should be reported when by doing so a better picture of the commercial value of the lot will be given.

(397) It is recognized that when ranges of percentages are long, such as 10 to 35%, the mathematical average may be varied slightly by examining an additional high or low sample, however, when sufficient samples have been examined this should be of little practical consequence. It has been found desirable to use only unqualified percentages under the quality, condition, size and pack headings on certificates. Do not use the word "approximately" to qualify an average percentage under these headings, regardless of the length of a range or in connection with an estimated percentage such as is sometimes used on grapes. "Approximately" is to be used only in connection with Grade statements. (Refer to par. 543 - 544).

(398) Never show a range from zero to a percentage but report thus:
"Most samples no decay, many samples 2 to 6%, average 3% decay."

Examples of reporting range and average percentages:

- (a) Grade defects 8 to 20% average 13%, mostly-----etc."
- (b) From 4 to 26% average 18% defects (or decay or off-size).
- (c) From 13 to 64% average 39% of potatoes are under 6 ozs.

(399) Use of Fractions.

Fractional percentages should not be used except in connection with reporting minute amounts of decay, such as "Less than 1/2 of 1% decay."

(400) Fractions may be used to good advantage in reporting more definite information than is possible by the use of general terms. However, the use of fractions should be limited to certain factors in which it is not feasible to report percentages, such as the following:

(401) 1. When the exact number of packages showing a certain condition cannot be determined, but when a sufficient number has been seen to justify a statement as to the approximate fractional part showing the condition reported.

Example: In approximately 3/4 of crates pack tight, remainder fairly tight.

2. When advisable to divide a percentage.

Example: 2 to 12%, average 8% decay (Blue Mold Rot) approximately 1/2 in advanced stages, remainder in early stages.

Certifying Bulk Loads. The variation found in bulk loads should not be treated like similar variations found in packages in applying the rule of double, or one and one-half times the tolerance. Variations found in samples of different parts of the load do not warrant throwing a load out of grade if the average obtained by properly chosen samples shows the lot as a whole to average within the tolerance. The car, as a general thing is sold as a unit and should be so inspected unless it is divided into bins by bulkheads, or cross partitions of various kinds. It is then proper to treat such bin as a separate unit, even though there may be but one variety in the whole car. Bulk loads are frequently divided, and if so, each part may be treated as a unit and certified separately if there is a material difference in the quality or condition of the two parts. If this is done, no attempt should be made to strike an average for the load as a whole. (402)

**** When Small Number of Specimens in Package. In commodities that are packed with a small number of specimens to the container, such as cantaloups, cauliflower, pineapples, etc., the following policy should be followed: (403)

1. When the number of specimens to the container vary because of different sizes, the range of defective stock should be reported by using both the number of specimens and the percentage, using parentheses to cover the percentage, i.e., Ranging from 1 to 4 melons per flat (11 to 50%), average 25%.

2. When the number of specimens in the containers do not materially vary, only the range of the number of defective specimens in the different samples examined and an average percentage need be reported, i.e., Range from 1 to 4 melons per flat, average 25%.

Reporting Averages on Restricted Certificates. When the entire contents of a car, truck, or lot in storage is accessible, and an unrestricted certificate can be issued, it is satisfactory to report the average as "for the load" or "lot," but when only part of the load or lot is accessible for inspection, and the certificate is restricted accordingly, the use of the phrase "Average for lot" is obviously incorrect. In a restricted certificate, the statement covering defects or decay should not refer to the entire load or lot but should read: "Range 2 to 15%, average 10%, decay, consisting of etc." (404)

GENERAL QUANTITY TERMS

(405) Averages cannot always be obtained, especially in reporting how many containers show a certain condition. In such cases the following terms may be used with the meanings given:

Term	Means
Occasional ¹	5% or less
Few	10% or less
Some	11 to 25%
Many	26 to 45%
Approximately half	46 to 54%
Most, Mostly	55 to 89% ²
Generally	90% or more ³
Practically all	96% or more

¹ Used only in reference to containers. See paragraph 407.

² See paragraphs 412 - 414.

³ See paragraphs 409 - 411.

(406) Complements of Most Quantity Terms Necessary. A complement is defined as one of two mutually completing parts. The terms "occasional," "few," "some," "many," "approximately half," and "most" require complements of some kind to account for the entire 100%. Likewise, under some uses "practically all," "generally," and "mostly" require complements. These complements may be: (1) another quantity term; (2) a percentage; (3) a fractional portion of bulk load or packages; (4) certain mark or marks, preferably with number of packages shown; (5) a definite portion of load shown by descriptive location, preferably with number of packages given if it is a package load. The type of complement used is determined by conditions. Examples of above conditions, the factor being dirt: (1) In most packages fairly clean, in many dirty. (2) Mostly slightly dirty, 5 to 25%, averaging 15% caked with mud. (3) Most of the load fairly clean; in approximately 1/5 of packages mixed through load stock is dirty. (4) In most packages clean; in J. Doe mark, (Loaders count 35 packages) dirty. (5) In most packages clean, in 40 packages in two stacks next to bunker B end of car stock dirty.

(407) The term "occasional" should be used only with reference to containers. The other terms would apply both to packages and individual specimens. Their use with reference to individual specimens, however, should be limited to such factors as color, cleanness, firmness, and maturity. Decay or specific blemishes and defects, and the part of a lot which shows a commercially undesirable state of maturity must always be stated in percentages of fractions.

Uses of "Generally" The word "generally" may be used on certificates without complement, with the meaning that such exceptions, as occur, are of no commercial importance. To say that a pack is "generally tight" means that exceptions are so few as to be unworthy of mention. (408)

Caution Regarding Overuse of "Generally." Inspectors frequently overuse "generally" through carelessness or a desire to play safe. The overuse of "generally" can weaken a certificate. If the inspector finds himself using "generally" 5 or 6 times on a certificate, he should check to see if his statements cannot be made more exact. In order to promote uniformity in this connection "generally" should not modify firm, if no other condition factors are present, unless more than 1% is fairly firm or soft. If 1% or less is fairly firm or soft, the product should be described as firm. The same rule applies to all descriptive terms such as color, form, smoothness, cleanness, etc. (409)

When Undersize or Percentage of Defects Such as Immaturity or Other Similar Factors do not Exceed 10%, Use "Generally" in Describing the Remainder of the Product. The quantitative term "generally" is defined as meaning 90% or more and, aside from the instructions in the preceding paragraphs, there is no exception made to the definition. Therefore, when the tolerance for undersize is 10% or less and the total percentage scored is over 1% and not more than 10%, "generally" should be used to describe the size of the stock that is not undersize. Likewise, when the percentage of immaturity is over 1% and not more than 10%, "generally" should be used in reporting the maturity of the remainder of the stock. The same policy applies to other factors. This policy does not include factors that are scored under definitions in the Standards such as staining of onions. (410)

Examples:

1. (Potatoes with 6% undersize). Generally 1-7/8 to 3-1/2, mostly 2-1/4 to 3 inches. From 1 to 10%, average 6% under 1-7/8 inches in diameter.
2. (Watermelons with 8% immaturity). Generally mature average including 8% immature melons.

"Generally" should not be used to qualify a statement reporting freedom from decay. If decay is present, it should be reported in percentage figures. If no decay is found, the statement "No decay" should be made. However, the use of "generally" in a decay statement in such instances as the following is permissible: "Lugs generally show no decay; in approximately 25 lugs stacked next A bunker, decay ranges from 2% to 8%, average 6%." (411)

(412) Uses of "Mostly." No complement of "mostly" is necessary when the word is used in reference to a narrower range of size or color within an inclusive range, or in reference to one or two degrees or stages of a factor within an inclusive range of degrees or stages. Such factors include pack, uniformity of size, and any factor of quality and condition.

Examples:

1. 2 to 3-1/2 inches in diameter, mostly 2-1/4 to 3 inches.
2. Hard to firm ripe, mostly firm.

(413) The term "mostly" without a complement may also be used where small percentages of a number of different kinds of defects have been found but only one or two of the most important are mentioned. Example: (Defects - 5% misshapen, 3% growth cracks, 1% worm damage, 1% sunscald). "Average 10% defects mostly misshapen and growth cracks." This paragraph is not to be considered as prohibiting mention of small percentages of such progressive factors as Blackheart, scald and Tipburn which may be of particular interest to those who may use the certificate. Also, if the lot is in storage or it is known that it is going into storage, small amounts of condition factors such as Late Blight of Celery, common Scald of Apples, etc., may be specifically mentioned as their presence may influence the storage plans of the applicant.

(414) When the term "mostly" is used, the product should show very plainly 55% or more of the factor as described. If it is desirable to state a "mostly," the inspector should make separate columns on the note sheet for recording the factors to which this term is to be applied. A certificate may be reversed on the statement of a "mostly" as well as the grade statement. If the "mostly" refers to a narrower range within an extreme range (as with diameters, weights of heads, color percentages on apples, etc.) enough representative specimens should be measured, weighed, or otherwise judged to establish with certainty the truth of the statements to be made. There is a tendency to over-use the term mostly in conditions like that shown in the first example above. Do not use this term to denote a narrower range within the extreme range if there is fairly uniform distribution between the extremes as in the following example:

Example:

No "mostly" should be shown for the following percentages - 2%, 6%, 4%, 5%, 8%, 2%, 7%. It is usually not necessary to state a "mostly" of the size of apples or other products which show such a narrow range as 2-1/4 to 3.

- 83 -

Uses of "Remainder." This word is not a proper complement of any (415)
of the general quantity terms except "approximately half." Its meaning
with the others would be entirely too indefinite. "Remainder" may be
used as a complement of a fractional portion of a load, however, as "In
approximately 3/4 of packages tight, in remainder fairly tight."

Use of "Approximately", "About". (416)

The word "about" may be used to divide a percentage. Thus "8 to 35% (417)
average 20% grade defects, about 1/2 consisting of worm injury, 1/2
bruises." It may be used also to divide number, or fractional proportions,
of packages. Thus: "In approximately 1/3 of packages stock is dirty, in
about 1/2 of these stock is also wet."

The implication of the word "approximately" is that an attempt has (418)
been made to determine the facts as accurately as possible. The implica-
tion of the word "about" is more loose and this word, except for the
purpose just mentioned, weakens a certificate.

Larger Proportion First. The more general condition should be (419)
stated first, the less common or exceptional one or ones following. This
order presents the picture with the more logical and consistent effect
than to emphasize the less general condition by mentioning it first. Thus:

1. Mostly tight, in some packages slightly slack.
2. Generally fairly firm, 5% soft.

Exceptions: (1) Where it seems more logical, stages of maturity
may be reported in their natural order, beginning
with the one least advanced.

- (2) When giving proportions of stock meeting require-
ments of the different grades in a combination
pack, the higher grade should be mentioned first,
and the amount of culls last. Thus: "Average
approximately 30% of stock is of U. S. No. 1
quality, 55% of U. S. No. 2 quality, 15% showing
defects affecting U. S. No. 2, mostly worm injury."

(420) Entire Lot Must be Accounted For. When a part of a lot is described as showing a certain condition, the picture must be completed. It is not sufficient to say simply "Mostly tight," or "In approximately 3/4 of packages stock in fresh." This raises the question at once whether the pack in the remainder of the packages is "very tight," "fairly tight," or "slack," and whether in the 1/4 of packages the stock is "fairly fresh," or "stale." Such a general quantity term must be used only with a complement as already shown.

(421) Do Not Omit Qualifying Terms. When a statement is made without qualification regarding any factor or condition, it applies to all packages or the entire lot. When the inspector states "Apples are firm, in few packages fairly firm," or "2 to 3 inches in diameter, 3% undersize," he is inconsistent. The proper statement is: "Apples are generally firm, in a few packages fairly firm" and "Generally 2 to 3 inches in diameter, 3% undersize."

(422) Reporting Fractional Percentages. Fractional percentages should not be used on the certificate except in the case of reporting small amounts of decay. When the average of the inspector's scores on the note sheet results in a whole number and a fraction, the following rules should be followed:

- (a) When the fraction is 0.4 or less, the percentage should be rounded out to the next lowest number. Example: 1.4% should be reported as 1% and 10.4% should be reported as 10%.
- (b) When the fraction is 0.5% or more, the percentage should be rounded to the next highest whole number, except when the tolerance is 1% or less. Example: 1.5% should be reported as 2% and 10.5% should be reported as 11%.
- (c) When the tolerance is 1% or less than 1%, report as "less than 1/2 of 1%" when the average is not greater than 0.4%. If the average is 0.5 to 0.9%, report as "less than 1%," except that an average of 0.5% defects should be reported as "1/2 of 1%" when the tolerance is 0.5%.
- (d) When the inspector finds his samples average less than 1/2 of 1% in excess of the tolerance (as 10.3%) he should take more samples and put the car definitely in or out of grade, if possible. If this is not possible, the .3 or other decimal over the tolerance, but less than 1/2 of 1%, should be dropped.

PACK

Reference to facing, completeness of wrapping, use of oiled wraps, shredded oiled paper, shims, liners, pads, lace collars, side curtains etc., are made under this heading. Special neatness or roughness of pack should be noted. Show use of crushed or chunk package ice under this heading, stating amount and where placed in package. The various Products Circulars will contain detailed information for reporting the packs of the products covered. (423)

It is often not necessary to mention the features of a pack which are usual and to be expected, but the unusual should always be noted. For illustration, it has become standard practice in all areas to ship citrus without wrapping; therefore, when citrus is not wrapped it need not be mentioned. (424)

Since filling of containers and tightness of pack are so closely related, no attempt will be made in this handbook to determine which terms should be applied to specific products or containers. If compliance with Standard Pack or Standards for Export is involved, ~~inspectors~~ should apply the terms and definitions in the Standards and Products Circulars. (425)

Condition of Pack for open or unlidded containers may be described in terms of fill - as level full, well filled, fairly well filled, slack, etc., according to the facts. For other containers, terms describing tightness or fill may usually be applied depending upon the product and types of containers (see Products Circulars). The following terms should be used: (426)

Very Tight - meaning the extreme of the condition described under Tight. Too tight for best results, and too much bulge for the good of the products, usually resulting in bad bruising. (427)

Level Full - meaning the product is level with the top edge of the container. (428)

Tight or Well Filled - means that the package is sufficiently filled to prevent movement of the product within, and to furnish the proper bulge with products and packages requiring a bulge. The amount of bulge may be shown in inches or fractions of inches. Hampers, lugs, crates and similar packages with covers will be filled so that the contents are in firm contact with the cover. (429)

- (430) Fairly Tight or Fairly Well Filled - means pack is not ideal, but is between tight or well filled and slack. Tight enough to prevent specimens from moving within the package sufficiently to cause injury under normal handling conditions. There may be a proper bulge to packages but slight looseness in layers. Hampers, lugs, crates and similar packages are filled so that the product may be slightly below the top edge but not more than 1/2 inch below.
- (431) Slack - This term is to be used when the pack cannot be described with any of the preceding terms, but should never be used without describing the slackness in fractions of an inch or in inches.
- (432) In Bulk or Sacks - When the product is in bulk or in sacks, the heading "Pack" should be followed by x x xs. The descriptive terms for "fill" should not be used for sacks because they do not give any information concerning the weight of the containers. Should this be in question, it can be determined only by actual weight and a report made under the "Pack" heading.
- (433) Cell and Tray Packs - The fill of tray and cell type containers can usually be judged by the degree of filling of the individual cups in the tray or of the cells in the carton. If there is no movement of the fruit, they can generally be considered well filled and if there is only slight movement of the fruit, they can be considered fairly well filled. At time of packing the bulge on tray packs is a guide as to the degree of filling. However, at times these packs may appear to be slack due to variations in the shape of the fruit or to softening and settling of the trays due to their absorption of moisture in storage. Whenever the filling of this type of container is in question, the final determination as to filling must be based on net weight marked on the container or any legal net weight which may have been established for the product in the container. Packages weighing 5% more than the standard net weight of the container will be considered well filled. Packages weighing less than the standard net weight will be considered slack. Due to the presence of trays or dividers in the containers, markings as to the cubic contents do not apply; they should be marked with the net weight.
- (434) Bulge - This is the distance of the highest part of the curve of the lid above the level of the top edge of the ends of the package or the top side slats when they are flush with the tops of the ends.

How to Judge Tightness or Fill. Tightness or fill should always be (435)
judged when the container is resting on its bottom. Inspectors should
also take into consideration whether the package is on a rigid surface,
such as a car or warehouse floor, or whether it is resting on the ends
of other crates which permit the bottom side to become convex. This
would make the crate appear slack at the top when in reality it is
fairly well or well filled.

Most products packed in ice should be judged by the tightness of the (436)
product in layers rather than the tightness of packages themselves
which may be determined by the amount of ice in the pack. See the
Products Circulars for discussion of pack for such products as lettuce,
carrots, etc.

Arrangement in Layers. The following terms refer to the arrangement (437)
of fruit in the layer:

Straight Pack: A pack in which the specimens in the layers above the (438)
bottom layer rest directly above the specimens in the layer beneath.

Diagonal Pack: A pack in which bottom layer fruits are placed so that (439)
they are not opposite each other horizontally, but fit partially into
the spaces between fruits in the adjacent row. Fruits in the second
and any additional layer are not placed directly over those in the
layer beneath, but are "nested" between the tops of the fruits in the
next lower layer. Thus the packed fruit is in diagonal rows.

Off-set Pack. A pack in which alternating space is left at the end of (440)
each row in each layer and the specimens above the bottom layer rest
upon one specimen in the outside rows and two specimens in the inside
rows in the layer beneath.

Bridge Pack. A pack in which a portion of an additional layer is (441)
placed in the package in order to secure a bridge. The products are
generally Iceberg type of head lettuce in crates, and tomatoes in lugs.

DETERMINING AND REPORTING NET WEIGHT

- * When requested to certify as to weight ONLY NET WEIGHT shall be reported. (442)*
- * Net weight only may be certified without making an inspection for grade
- * or condition. Charges for this service should be made on an hourly rate
- * basis with the minimum fee usually of two hours.
- *

DETERMINING WEIGHTS AND TARES

- (442a) The inspector should always be on the alert for packages which are exceptionally heavier or lighter than usual and include a proportionate number of these packages in the determination of tare. Water-soaked or mud-caked packages or those made of exceptionally heavy material as well as those of lighter material should be emptied and weighed to determine the average tare. Five (5) containers are usually sufficient when the tare weight is fairly uniform, but more than 5 should be used when wide variations in weight are found.
- (442b) Packages containing pack ice should be emptied and only the product weighed in determining net weight. The container and pack ice are weighed to determine tare and reported only on the applicant's request giving the range, not an average.
- (442c) The inspector should always note any and all unusual circumstances, such as, torn sacks with contents spilled; spotted sacks; re sewn or repaired containers; wet, leaky, mud-caked, slats broken, etc.; and especially if the contents shows excessive aging, loss of moisture, wilting or deterioration that may affect the weight of the product. In addition to describing the above factors under "Condition of Containers" any such containers weighed should be annotated on the notesheet for future reference. This may be done by checking or circling the weights on the notesheet of those containers which have indications of deterioration.
- (442d) Lots with positive lot identification, such as, "Fed-State Insp. Lot 267, 5-13-79," should be checked carefully in relation to date of manifest, date of inspection(s), and deterioration because of possible reversal on net weight certifications.
- (443) When requested to certify as to specified or marked weight the following procedures shall be used for both Stationary lot Sampling and on-line Sampling.

"Stationary Lot" (Random selection of sample containers from a lot for which the production has been completed. This type of lot is usually stored in a warehouse or in some other storage area and is offered intact for inspection).

"On-line" (Random selection of sample containers from a production line. Production is in progress while on-line sampling is conducted. Portion of production can be accepted, rejected, or held pending further sampling results during on-line sampling).

-88a-

- (1) Disregard lot size.
- (2) Stationary lot: Randomly select 36 sample units.
On-line: Weigh sample containers at timed intervals.

At least 36 sample units shall be weighed for any lot, and the total number of sample units to be weighed when certification is based on a days run equal approximately 36 sample units per car lot equivalent.

- (2a) Modification of Net Weight Certification Policy
Exception to the minimum number of containers to be weighed (36) per lot may be made only in the following circumstance:

On-line certification when the carrier lot consists of more than one identifiable lot; that is; brands, sizes, varieties, type of pack, etc.

It is permissible to officially certify net weight on partial lots using the following table:

<u>No. of Containers in Lot</u>	<u>No. of Containers to be Weighed (min)</u>
0 - 250	10
251 - 500	20
501 - 750	30
751 - 1000 or more	36

**** When any container in a lot is below the marked or specified weight it will be necessary to weigh 36 sample units, instead of the 10, 20, or 30 sample units as shown above.****

- (3) When a scale reading is between two graduation marks, read to the nearest graduation mark.

**** (4) Weigh and record each sample unit to the nearest: 1/2 ounce for containers packed to a marked or specified weight of less than 10 pounds; and 1/4 pound for containers packed to a marked or specified weight of 10 pounds and over.****

-88b-

- (5) After weighing all sample units the exact average net weight must meet the weight marked on the containers or any weight specified by the applicant.
- (6) No individual sample unit shall weigh less than the appropriate reasonable shortage limit specified in Table I.

(444)

When lots are certified as failing to meet the requirements of average weight marked or specified or reasonable shortage limit in individual sample units, the certificate must show under the "Pack" heading the reasonable shortage limit, the range in weights, exact average, and percent of sample units failing to meet the reasonable shortage limit such as:

- Examples: (1) 2 lb. package (Fails average weight)
Reasonable shortage limit: 30.00 ounces net.
Range from 30.50 to 33.50, average 31.52 ounces net.
- (2) 1 lb. package (Exceeds reasonable shortage limit)
Reasonable shortage limit: 14.50 ounces net.
Range from 14.00 to 16.50, average 15.88 ounces with 9 percent of sample units below 14.50 ounces net.

(445)

When lots are certified as meeting the requirements of average weight marked or specified and reasonable shortage limit in individual sample units, the certificate must show under the "Pack" heading the range in weights such as:

- Examples: (1) Ranges from 30.50 to 33.50, averaging more than 32 ounces net.
- (2) Ranges from 16.50 to 19.50 ounces net.

-88c-

The actual weight certification shall appear under the "Grade" heading on the inspection certificate such as: (446)

- Examples:
- (1) Meets marked weight.
 - (2) Fails to meet marked weight account of sample unit average below declared weight.
 - (3) Fails to meet marked weight account of unreasonable shortage in few, some or many sample units.

Reporting Percent of Containers Under Specified or Marked Weight (447)

It is permissible, at applicants request only, to report under the "Remarks" heading on the certificate the percent of containers under the specified or marked weight.

The regular spring balance scales furnished to inspectors are not sensitive enough to weigh to the nearest 1/2 ounce. Therefore, if inspectors are requested to report weights of small packages, they should use more sensitive scales. Prepackers and chain stores who put up small packages are usually equipped with scales sensitive enough to weigh accurately to the nearest 1/2 ounce. (448)

When inspections are made for weights, the following information shall be shown on the note sheet for future reference: (448a)

1. Type of scale, i.e., spring or beam balance,; name of scale, e.g., Chatillon etc. used.
2. Graduations of the scale. (1/4 ounce, 1/2 ounce, ounce, 1/4 lb., 1/2 lb., or pound.)
3. Owner of scale (whether Government scale or applicant scale or other source).

Always place the scales on a firm and level support. When using spring balance scales, counter or bench type such as model F-10Z, sample containers must be centered on the scale platform. This type of scale will only weigh accurately when the sample container is centered on the scale platform. Before using this type of scale always check your zero-load balance; i.e., the dial must indicate zero when there is no sample container on the scale. Regardless of the source (applicant, government, etc.) of any type of scale to be used, precheck the accuracy of the scales using an approved standard test weight. (448b)

TABLE I
 Reasonable Shortage Limits 1/
 Marked or Specified Net Weight 2/ No individual container
 may weigh less than

Pounds	Grams	Pounds & Ounces	
.50	190.8	---	6.50 oz.
1.00	405.6	---	14.50 oz.
2.00	859.2	1 lb.	14.00 oz.
3.00	1288.8	2 lbs.	13.50 oz.
4.00	1718.4	3 lbs.	12.50 oz.
5.00	2148.0	4 lbs.	11.50 oz.
8.00	---	7 lbs.	10.00 oz.
**** 10.00	---	9 lbs.	8.00 oz.
15.00	---	14 lbs.	8.00 oz.
20.00	---	19 lbs.	4.00 oz.
25.00	---	24 lbs.	---
50.00	---	48 lbs.	---
100.00	---	96 lbs.	---

1/ When certifying packages less than 10 pounds and not listed on the table do not apply a reasonable shortage limit. Lot will fail to meet marked or specified net weight only if sample units average below marked or specified net weight.

2/ Certifying marked or specified net weight for containers over 10 pounds which are not specifically listed in Table I, no individual sample container may be more than 4 percent below the marked or specified net weight.

Example: For a lot with containers marked 38 lbs., no individual sample may weigh less than 36-1/2 lbs.

Added, October 1990, HU-108-6(b)

-88e-

**** CERTIFYING WEIGHT OF PRODUCTS IN BULK BINS (448c)

Current instructions provide that we report only net weight, and not gross weight. However, bulk bins are exempt from the net weight only restriction, and therefore gross weight may be reported only for products in bulk bins.

Scales must be prechecked for accuracy using an approved standard test weight prior to a weight inspection. However, our check weights are insufficient for checking the accuracy of scales capable of weighing bulk bins. Therefore, we will consider the applicant's scales prechecked if local weights and measures officials (State, County, or City - with equipment capable of checking such scales) check the scales and verify the accuracy of them immediately prior to weighing in the presence of the inspector. Scales with seals previously applied by weights and measures bureaus under local laws will not be considered "prechecked for accuracy."

All bins of the lot, load, or portion of lot remaining, regardless of the lot size, will be weighed, and the range and average gross weight shall be reported under the pack heading. Do not attempt to determine a tare weight by weighing a few empty bins, because the weights of such bins vary too much for accurate certification.

As under current instructions, the notesheet will show the type of scale, the graduations of the scale, and the owner of the scale.

If the foregoing procedures are not possible, inspectors may, at applicant's request and expense, accompany the load to a CERTIFIED PUBLIC SCALE and witness and record the scale readings on our certificate for the gross weight of the load and/or the empty weight of the truck or trailer.

Exceptions to the above may be granted by the Washington, DC office on a case by case basis. ****

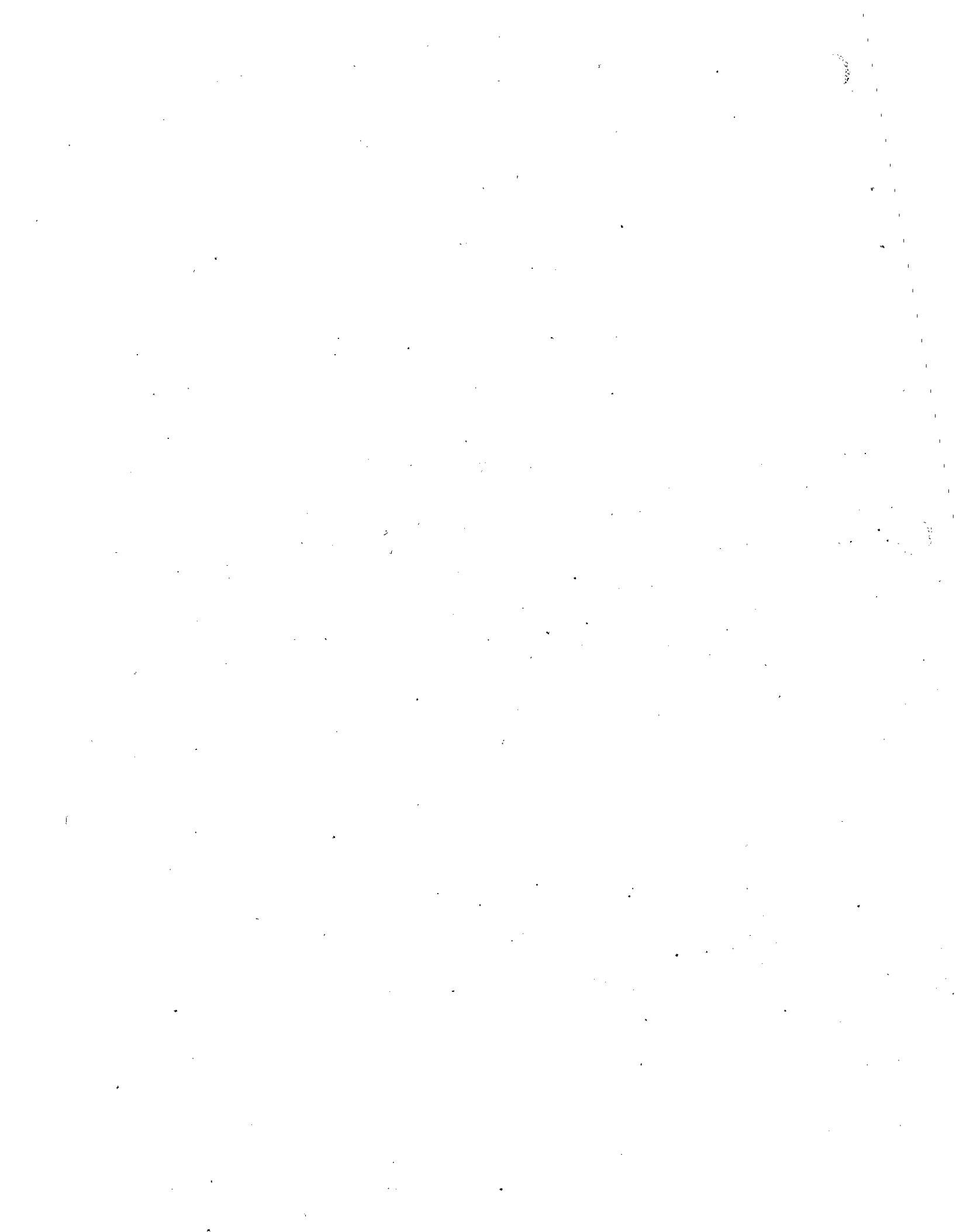

Pack a Factor of Condition. When certificates are restricted to reporting condition only at the applicant's request, as is frequently done on apples and pears in storage, the tightness of pack is a factor of condition and should be reported under the "Pack" heading. Wrapping and arrangement are not subject to change and should not be reported in such instances. (449)

SIZE

Under this heading, depending on the product, are covered - (1) diameter and length, (2) weight, (3) uniformity of size, (4) reference to counts being as marked, (5) bunching. See the Products Handbooks or other instructions regarding size of specific products. (450)

Range of Size. If minimum and maximum sizes for the products are set by standards, or are specified by the applicant in connection with the standard, then the diameter, length, weight, etc. must be stated with reference to tolerances for these standards. If the size statement is not on the basis of a standard or a specified size, the occasional specimen below or above a general minimum or maximum range should be ignored. For example, if only a single specimen in a sample is found to be 2-3/4 inches, and none of the remainder above 2-1/2 inches, mention of 2-3/4 inches as the maximum gives a wrong impression, 2-1/2 being the more correct for the purpose of the certificate. (451)

"Mostly." When stating range of size, unless this range is comparatively narrow or the distribution of sizes is not fairly uniform, it may be desirable also to show the size of most of the specimens, in order to give the general impression created by the lot. As "2 to 3-1/2 inches diameter, mostly 2 to 2-3/4 inches." In showing a "mostly", be sure it represents well over 55% of the lot. If the size is fairly uniform, no "mostly" need be stated. (452)

Reporting Undersize Within or Well Within Tolerance. It will be satisfactory to use the term "undersize within" or "undersize well within" tolerance, or "undersize averages within the tolerance," except where it will be necessary to determine the percentage of U. S. No. 1 Quality, or where a specific request is made to show the exact percentage under a minimum mark or size. (453)

In a product where size is a factor in determining grade, such as in the case of minimum size of potatoes, onions, etc., careful percentages should be determined, being sure to see representative samples of the lot. The same policy applies to a specified maximum size. (454)

- (455) In cases where size is not a definite factor of grade, the general overall size range should be shown and usually stating a "mostly size."
- (456) The method of reporting size on some special products requires separate instructions, and these will be found in the various Products Handbooks.
- (457) Reporting Counts or Packs. The size or count of citrus fruits, boxed apples, boxed pears, tomatoes in lugs, celery in crates, etc., should be shown under the "Products" heading, if they are marked on the container. If these are not as marked, this fact should be shown under the "Size" heading, describing the condition found, generally by stating if possible the percentage which is mismarked, and how much it varies from the given size. If the counts or packs conform to marks, this fact need not be shown when certifying tier packed products. However, in the case of such products as celery and cauliflower, which may be easily miscounted because of irregular placing, it is well to state that counts are as marked. This should be done under the "Size" heading. Uniformity or lack of uniformity of sizing should be reported under this heading when the product is sized to conform with this terminology. Refer to the standards and the commodity handbooks. (See PACA Rulings on off-count, par.116- 119).
- (458) Bunching. Bunches are irregular, fairly uniform, or uniform (rarely the latter) in size. It often is necessary to state the range in number of bunches found to the crate. If the product is a root crop, the range in number of specimens in the bunch and a "mostly," if any, should be reported. Reference to Standard Bunches should be made under the "Grade" heading, but the facts will be given under "Size."
- (459) Standard Pack, Standard Bunching, etc. If the grade statement is to include standard pack of citrus fruits, lettuce, plums or prunes, style of pack for tomatoes, or standard bunches of beets, carrots, radishes, turnips, etc., the details will be covered under the "Size" and "Pack" headings. The actual certification will appear under the "Grade." Thus: Lettuce - "U. S. No. 1, Standard Pack." Tomatoes - "U. S. No. 1, U. S. Extra Row Pack.

QUALITY AND CONDITION

- (460) Under the Quality and Condition heading on the certificate should be a concise description of the product that will give the reader a clear and accurate picture of the lot. The good features of a lot should be described as well as the poor ones.

"Quality" as used by the Inspection Service refers to the more permanent factors of a product, that are not normally considered subject to change in storage or transit, such as cleanness, shape, color of apples, solidity of lettuce and cabbage, growth cracks and second growth of potatoes, etc. (461)

"Condition" refers to the factors of a product that are subject to development, advancement or other change in transit and storage, such as decay, breakdown, stages of ripeness of fruit, yellowing of leaves of leaf vegetables, color of tomatoes, tightness of pack, etc. (462)

Grade and Standard Defined: A "grade" is a set of specifications of quality and condition for a product which has been promulgated for use under a specific name, such as U. S. No. 1. (463)

A "standard" includes the one or more grades applying to the commodity and also other specifications in addition to quality and condition such as those covering size, pack, marking, etc. and the definitions of the terms used in the grades. For example: The standards for fresh tomatoes are published under a title "United States Standards for Tomatoes" which includes four grades plus "Size Requirements", "Application of tolerances", "Style of Packs", "Irregular Pack", "Color Classification", and "Definitions". (464)

Descriptive Terms. Each grade specifies the factors that are pertinent to the commodity such as cleanness, color, maturity, shape or form, smoothness, firmness, ripeness, etc. These should be described in general terms, using the descriptive terminology that is supplied and defined in the grades and/or handbooks, unless they fall below the requirements of the grades, in which case they must be scored as grade defects. In a few commodities factors that are not specifically mentioned in the grades or have no grade requirements also affect the market value of the lot and should be described. An example is blushed color in the U. S. No. 1 grade for peaches. The use of terms such as "good, fair, poor or sound" and others which generally express only individual opinion are excluded from use on certificates unless they have been officially defined. (465)

Descriptions should be made as accurate and brief as practical and should usually be made by using complementary general terms such as: "mostly well, some fairly well shaped." Inspectors should avoid using more indefinite descriptions, such as: "fairly well to well, mostly well shaped." or "hard to firm ripe, mostly firm". Because as accurate information as possible is important to shippers in connection with their sales, shipping and storage programs, Shipping point inspectors should use the more precise descriptive terminology, thus: "Mostly firm, some hard, few firm ripe". (466)

- (467) Reporting Quality and Condition Factors Which Do Not Affect Grade. In general, the inspector should avoid mentioning factors that are not serious enough to affect grade, without a specific request, with such exceptions as potatoes sold as seed stock where it is desirable to show net necrosis, rhizoctonia and scab, even though not serious enough to affect grade, but they may be shown at specific request of applicant followed under a "Remarks" heading by statement to this effect.
- (468) Color. The commercial importance of color varies widely with the different products. In most of the dessert fruits it is a matter of prime importance, and it is almost equally so in many of the green vegetables. In root crops it is usually secondary to some other factors.
- (469) The amount of color is very important in the dessert fruits. It is generally reported in fractions or percentages of the surface area, which is covered with color characteristic of the variety. Fruits showing normally only a blush or partial color may be described as "well colored," "fairly well colored," or "poorly colored" unless being inspected under a grade which defines the amount of color in other terms. In this case description of the color should be made to conform to the wording of the grade, as "tinge of color," or "most apples show from a tinge of color to full red, mostly 1/4 to 1/2 good red color."
- (470) Brightness of color adds greatly to the attractiveness of a product. In green vegetables it is an index of the freshness of the product, while in colored fruits it is second in importance only to the amount of color.
- (471) The appearance of potatoes and various root crops is generally described from the standpoint of freedom from dirt rather than their real color. Brightness, dullness, and other factors affecting their general appearance should be described under the "Quality and Condition" heading.
- (472) Remember the term "green" may refer to color alone and be no indication of maturity or ripeness, or it may have the meaning of "not mature." Whenever this term is used to express the former meaning, the phrase "Green color" should be used.
- (473) Maturity. The term "mature" will be used in the sense of being that stage or degree of development of a fruit or vegetable demanded by the use to which it is to be put.
- (474) Distinction Between Mature and Ripe. Although the term "mature" and "ripe" both refer to fullness or completion of growth, "mature" or "maturity" is the more restricted term and means the completion of development, while "ripe" or "ripeness" indicates readiness or fitness for use. Thus a "mature" tomato or a "mature" apple may attain full development without being ripe, that is, without being fit for consumption. It should

- 93 -

be remembered that this term has come to be used differently by various groups, thus the botanical and horticultural meanings of the term are not the same. A fruit or vegetable may be fit for use, that is, for eating, which is the horticultural meaning of the word ripe, without being ripe in the botanical sense, that is, without having mature seeds fit for germination, or even without being mature in the botanical sense, that is, without having full development. Many so-called leafy or green vegetables, such as lettuce, cabbage, spinach, and many others, such as snap beans and cucumbers, are examples in point. Refer to the commodity handbooks or your supervisor for instructions when maturity is a factor in the inspection.

Distinction Between Ground Color and Varietal Color. Care (475)
must be exercised in the case of some deciduous fruits, such as apricots and certain varieties of pears and plums, to avoid confusion in describing the ground color, which relates only to maturity, and the blush or red color. In such cases it is best to mention ground color in connection with maturity statements, as: "Pears hard, green ground color."

Variation of Maturity or Color in Lot Should be Shown. Where (476)
widely varying conditions of maturity or color are found within a given lot, a general description should be given showing the irregularity and range, and the approximate amount of the stock showing each stage of maturity or color wherever possible, rather than to attempt to report an average condition for the entire lot, as: "In most boxes pears mostly hard, many firm, in many boxes mostly firm, some firm ripe."

Policy in Describing Freshness and Firmness on the Certificate (477)
When Specimens Affected by Soft Rot or Other Decays or Other Factors Limited by Tolerances. When describing the freshness and firmness of a product, soft rot and other decays limited by special tolerances shall be considered in determining the quantitative terms to be used. Due to the rapid deterioration of specimens affected by these injuries, they shall not be considered fresh or firm as these terms are defined in the U. S. Standards or Commodity handbooks, regardless of the area affected. Also products should not be described as fresh or firm if other factors have caused deterioration beyond that permitted under the definitions for "fresh" and "firm." In describing the freshness or firmness of that portion of a lot not affected by soft rot or decay limited by special tolerances, or advanced deterioration by other disease, general terms should be used.

Handling Aphids as Permanent or Condition Factor.
Inspectors are often uncertain whether to handle damage and serious damage (477a) by aphids as a permanent defects or as a condition defect. The instructions on the subject vary and in some cases conflict. In recent years the situation has been complicated by truck transportation and the greater possibility of changes in temperature in transit. At temperatures of from 40 to 50 degrees F. the reproduction rate is very slow. For all commodities, score damage or serious damage by aphids as a permanent defect when they are dead. When aphids are alive consider as a condition defect. A specimen with both dead and live aphids present shall be considered as a condition defect.

-94-

Examples:

1. (Citrus fruit with 5% Blue Mold Rot). Generally Firm. Decay ranges from 1% to 8%, average 5%, Blue Mold Rot, in early stages.
2. (Potatoes with 2% soft rot). Generally firm. Soft rot in most sacks 1% to 5%, in some none, average 2% soft rot.
3. (Celery with 8% serious damage by pithy branches). Generally fresh. Damage by pithy branches ranges from 10 to 15%, average 12%, including 8% serious damage.

(478) Grade Defects. Grade defects may be a result of injury, damage, serious damage or very serious damage. These terms are defined in the Standards for each commodity where applicable. Individual specimens may not be affected to an extent more than that permitted by (1) any one defect; (2) or more than to an equivalent extent by a combination of lesser degrees of 2 or more defects; (3) or more than by a combination of lesser degrees of different types of the same general defect, such as light, slightly rough and rough scars. In other words, to meet grade requirements a specimen may not have a poorer appearance or a greater "waste" when such appearance or waste is the result of a combination of causes than it could from one cause.

(478a) When a scoring guideline for a defect is specifically defined in a standard, a specimen affected by that defect can only be scored by the definition for injury, damage, serious damage or very serious damage that is included in that standard. The general definition for injury, damage, serious damage or very serious damage may only be used to score defects without specific scoring guidelines defined in the standard or to score a specimen with a combination of defects, none of which would be scored individually.

(479) The term "grade defects" should be used to report all blemishes that are serious enough to affect the grade on which the product is being inspected. When certificates are being issued on grades other than U.S. No. 1, the grade should be stated in connection with "grade defects" unless the grade is quoted under the "Products" heading, thus: "Grade defects of U.S. Fancy within tolerance" or "Grade defects of U.S. No. 2 range from 6 to 20% - - - - -." ****

(480) In combination grades the statement of defects may be made on the basis of the lowest grade in the combination, thus (Combination U.S. No 1 and U.S. No. 2). "Defects of U.S. No. 2 within tolerance," or on the basis of the combination grade, thus: "Defects of U.S. Combination within tolerance."

In commercial grades "defects of U.S. Commercial within tolerance" should be reported when the lot meets grade requirements. (481)

**** Where there is a grade for the product, the expression "grade defect" will in most cases be sufficient to describe the degree of injury. However in the grades for some products and under some circumstances, it is desirable or necessary to show the degree of injury, such as when a separate tolerance for serious damage is included in an over-all tolerance or it is necessary to show compliance with other limitations. The terms "damage" and "serious damage" should be used to describe the degree of injury by defects when they can be classed under the definitions of these terms in the grades. (482)

Example: (Peaches) Grade defects 5 to 15%, average 12%, mostly damage by bruises including 8% serious damage and 1% decay.

When there is no established grade for the product, the extent of injury should be accurately described so that the reader may get a clear picture of the product, thus: (Casabas) Mature, firm and well formed. Average 4% of melons show hail scars affecting aggregate areas 2 to 3 inches in diameter. (483)

In noting defects, minor blemishes, which are of no commercial importance, should be ignored. The individual specimens should not be scored on the close basis employed in judging prize products. When grade is involved, only such defects as are excluded from the grade in question should be scored. For instance, in scoring C grade apples, U.S. Utility grade apples, U.S. No. 2 grade potatoes, etc., practically all specimens may show certain blemishes which are permissible in the grade, but these should not be reported as their presence is the cause of the stock being in such grade. Were it not for these, the stock would be classed under a higher grade. (484)

General Policy in Describing Defects and Irregular Conditions. One of the chief purposes of our certificates is to show the commercial possibilities of the product being certified. In this connection it is important that all defects which are serious enough to affect the grade being used should be noted and described in such a manner that interested parties can form a clear opinion regarding the lot. When no grade defects are present, it is equally desirable that this circumstance be noted. The statement "practically no defects" or "practically none" may be used when less than 1% defects or undersize are found, except in the case of soft rot and decay. (485)

(486) When Quality or Condition Differs According to Brands, Sizes, Variety, PLI, or Grade Marks. Whenever there is a marked difference found in quality, condition or size that definitely can be associated with certain types of packages, brands, sizes, varieties, PLI marks or grade marks, then the certificate and notesheet must report such differences as separate lots.

(487) No firm rule can be established on the amount of irregularity required before such lots must be reported separately. However, when some lots would fail to grade and others would pass, even on the basis of a condition only inspection, then those lots definitely must be reported separately. On lots that fail, wide differences in total defects or a single defect such as decay would justify reporting as separate lots. Any time an inspector feels that reporting as separate lots would provide a clearer picture of the findings, then it is always permissible to report as separate lots.

(488) Whenever such lots are to be reported as separate lots, sufficient samples must be examined to clearly establish that there is a marked and consistent difference that can be associated with the package markings. If the lots were initially sampled as one lot, it may be necessary to take additional samples from one or more of the lots when a marked difference in quality, condition or size is discovered.

(489) Not Permissible to Average In-Grade Lots with Out-of-Grade Lots. Anytime the applicant requests that such lots be reported as separate lots, they shall be reported as separate lots; however, the lots may not be combined, even at the applicant's request, if there is a marked difference in quality, condition or size. It is not permissible to combine readily identifiable in-grade or properly sized lots with identifiable out-of-grade or off-size lots in order to cause the combined lot to either fail or pass. For example:

A shipper requests an inspection on a load of apples marked U.S. Extra Fancy, sizes 88, 100, and 113. The 88s fail to grade account grade defects, but no sample exceeds the container tolerance, and, combined with the other sizes, the entire load would pass. The applicant requests that the lots be combined so that the load can be shipped as meeting the grade marked. However this is not permissible as it could result in the shipment of out-of-grade, misbranded merchandise, and other parties having a financial interest in the load could be misled by our certification. The 88s must be certified as "failing to grade U.S. Extra Fancy." The 100s and 113s shall be certified as U.S. Extra Fancy.

Revised, July 1993, HU-119-8-(a)
Page 97, Para. 491-493, General Shipping Point
Inspection Instructions, January 1966

-97-

Other markings such as growers' marks, lot numbers, or packing house code numbers should be noted next to the samples on the notesheet, but no attempt should be made to certify as separate lots unless specifically requested to do so by the applicant (see paragraphs 214 and 215). (490)

**** Tolerances. With the exception of grades for certain raw products for processing, all grades provide tolerances for defects. The standards contain two types of tolerances: (a) Lot Tolerances; and, (b) Container Tolerances. (491)

(a) Lot Tolerances. These are part of each grade and specify the average percentage of defects permitted in the grade. This is generally 10%, 8%, 6% or 5% depending on the commodity and usually includes tolerances for decay of 1 or 2% and in some grades includes a tolerance for serious damage. On some commodities, additional separate tolerances are provided for size and special factors such as color of prunes. (492)

(b) Container or Package Tolerances. The tolerances for the standards are on a container basis. Most standards specify that individual packages or samples may vary from the specified lot tolerances for defects and off-size by not more than 1½ times a tolerance of 10% or more and not over double a tolerance of less than 10%. The standards for some commodities have variations from this general policy, especially in reference to small packages and in consumer grades. The inspector should carefully check the standards on which they are working for provisions in this respect. They will be found under headings such as "Application of Tolerances," or "Introduction." Many of the older standards do not contain specific instructions as to the application of tolerances. In such instances individual containers shall have no limitations on the percentage of defects or off-size. If the average for the lot or a particular tolerance is not exceeded, the lot will grade. (493)

Revised, May 1992, HU-114-6(d)

(494) One Defective Specimen Allowed in a Package. Many standards contain a provision that one defective specimen may be allowed in each package regardless of the percentage involved, provided the lot meets the average tolerance. This has been interpreted as meaning one for each separate tolerance such as for size, external grade defects, and when applicable, internal defects.

(495) Reporting Defects Within Tolerance. When a lot is within a grade's tolerance, the inspector should not report the defects in percentages unless it is requested by the applicant or he is instructed to do so, for some special reason, by his supervisor. Generally one of the three statements defined below should be used:

(496) 1. "Grade Defects Within Tolerance": This statement is to be made when the average of defects does not exceed the tolerance and the defects in any container do not exceed the grade tolerance.

(497) 2. "Grade Defects Average Within Tolerance:" This statement is to be made when the average of defects does not exceed the grade tolerance and no sample exceeds the container tolerance, and the number of containers which exceed the trade tolerance is within container limitations. It also applies, regardless of the range, when there is no container tolerance, such as for small packages in some standards.

(498) 3. "Grade Defects Well Within Tolerance": This statement means that no container may exceed the grade tolerance for total defects, or for serious defects, decay or any other factor for which a specific tolerance is provided, and that the average percentage of each such defect in the lot may not exceed one-half of the respective tolerance.

(499) When DPSC and similar purchase orders specify "well within," this should be certified in the grade defects statement but not under the "Grade" heading. The "Grade" heading could state thus: "U. S. No. 1 - Meets purchase order specifications;" an appropriate variation may be used.

"Grade Defects Each Lot Within Tolerance." This is the accented (500)
statement when there are two or more varieties or grade lots or two or
more types of packages and when all are up to grade. When in one lot, or
some lots, the grade defects are well within tolerance and in another, or
others, they are simply within tolerance, then show for all lots simply:
"Grade defects within tolerance."

Reporting Defects Exceeding Tolerances. If a lot does not meet (501)
the requirements of a specified grade, the range and average of defects
that put the lot out of grade must be reported regardless of the number
and size of samples examined or of how narrow the range may be, unless
the range is narrow and the average appears inconsistent with the range,
such as "from 21% to 23%, average 20%." In such instances it will be
satisfactory to state, for example: "Defects occur uniformly in samples,
average 20%. This policy applies when the lot is reported as meeting a
percentage of grade quality as well as when failing to meet a specified
grade.

When the percentage of U. S. No. 1 quality is to be certified, the (502)
percentage of defects and off-size which are counted against the grade,
must be reported on the certificate under the proper headings. In such
cases, do not use such statements as "undersize within tolerance" or
"grade defects within tolerance, but show the exact percentage. When a
lot is found to be in excess of tolerances, the principal defects and
condition defects should be stated as part of the Grade defects state-
ment, thus: 8 to 15% average 12% defects, mostly russet and dirt.

Counting Defective Specimens More Than Once. In scoring and in (503)
calculating the percentage of defective stock generally count but once a
specimen which shows two defects, either classifying the under grade
specimens according to the grades into which they fall or classifying
them with the defects which most seriously affect the grade or with which
they will total more than the tolerance; For example, if 6% of a lot of
potatoes are damaged by external defects and 1% damaged by both external
and internal defects, this 1% must be counted with the external defects,
for it is evident that the lot contains 7% external defects which is more
than the tolerance. The fact that the lot is out of grade cannot be
changed by scoring the 1% which shows both external and internal defects
with the latter.

- 100 -

- (504) When size is part of the grade, undersize specimens that are defective should be scored twice, first for undersize, and second for grade defects for the reason that size and grade defects have separate tolerances in the grades. Generally the percentage of undersize specimens that are defective will be negligible and will make no difference in the grade certification. Under ordinary conditions when the percentage of undersize specimens that are also defective amounts to 1% or more, the usual size statement should be made, giving the total undersize, including those specimens that are also defective. No mention of defects should be made under the "Size" heading. However, this information should be reported under the "Quality and Condition" heading, thus: "Range from 5 to 25%, average 15% defects, mostly surface scab, cuts and second growth, including 2% also reported above as undersize." Defective oversize specimens should be treated the same way as undersize specimens that are also grade defects.
- (505) Reporting Defects of Commercial and Combination Grades. To promote uniformity between shipping point and terminal market inspections and to avoid conflicting percentages of defects, it will be the policy to report "defects within tolerances" when the product meets the grade specifications of a Commercial grade. If a lot of either Commercial or Combination grade fails to meet the grade requirements, naturally it will be necessary to show the percentage of defects the same as when a lot fails to meet the No. 1 grade.
- (506) Reporting the Higher Grade in Combination Grades. In case of Combination grades which require a percentage of a higher grade, the percentage of the higher grade need not be shown unless it is requested by the applicant. When the applicant requests the percentage of the higher grade be reported as a description of quality but not qualifying the Grade, it may be reported under this heading.
- (507) Dirt on Washed and Unwashed Root Products. The same interpretation of "damage by dirt" should be applied to potatoes, carrots, parsnips and other root crops when they have been washed as when they have not been washed. The term "washed" does not necessarily mean clean.
- (508) Scoring Loose Dirt in Containers of Root Crops. Inspectors are often confronted with the problem of reporting large amounts of loose dirt in containers of potatoes, carrots and other root crops. The manner in which this should be handled depends somewhat on the circumstances.

In the case of root crops being delivered to processing plants, it is quite general practice in some areas to consider loose dirt in containers as tare weight. For example, in a container of carrots with a net weight of 50 pounds including 2 pounds of loose dirt, the basis for calculating the percentage of defects of the roots would be 48 lbs. and the 2 pounds of dirt would be considered tare weight and deducted from the total net weight of the container. The processor would settle for the container of carrots on the basis of 48 pounds delivered. This method has proven satisfactory. (309)

Under circumstances where there is no agreement between buyer or seller on the method of handling loose dirt, the above method is not applicable. However, if an applicant for inspection requests it, the amount of loose dirt may be determined in sample containers and reported under Remarks. For example: "Ranging from 1/2 pound to 4 pounds, average 2 pound loose dirt in sacks. Amount of loose dirt in sacks reported at applicant's request." (510)

Freezing Injury. Freezing and freezing injury are seldom found when inspecting most commodities at shipping point. However, such commodities as potatoes and onions shipped from winter storage and fruit from cold storage are sometimes frozen or show freezing injury. (511)

A distinction should be made between stock that is frozen and that which shows freezing injury. When the product is still in a frozen condition, with ice crystals present in the tissues, the term "frozen" is the proper designation and specimens so affected should be scored against the tolerance for soft rot, decay or breakdown. It is not necessary to state "ice crystals present." (512)

When the product is not in a frozen condition at the time of inspection but it shows the typical conditions that indicate it has been frozen, such as shriveling, flabbiness, soft and leaking or internal discoloration, the term "freezing injury" should be used. Such specimens should be described and scored on the basis of "damage" as instructed in the grades and commodity handbooks. Whenever the term "freezing injury" is used it should be followed by a description of the injury, such as: "soft, wet and flabby," etc. (513)

Decay. Decay is a deterioration or decline of the plant tissues involving decomposition which is induced by fungi, bacteria and similar organisms, and which is of a complete and progressive nature. Care should be taken to avoid confusing dead or watersoaked tissues with decay as they are often quite similar in appearance. Usually decayed tissue will disintegrate when rubbed between the fingers while bruised or watersoaked tissue will crumble but will retain a certain amount of body or texture or will roll up into a small particle or a ball. (514)

- (515) While it is not always possible to determine what caused the development of decay, this should be done if possible, if the tolerance is exceeded. Examples are Blue Mold Rot following punctures or Slimy Soft Rot following lenticel injury.
- (516) Report Soft Rot Separately. If the restrictive tolerance for decay in the grades is for soft rot, such as is the case in the potato grades; then the words "soft rot" should be used to report it on the certificate so that it will not be confused with the dry or moist types of decay that are scored under the definitions of damage against the tolerance for other defects.
- (517) Reporting Percentages of Decay. When the tolerance for decay is 1% and the scoring less than 1/2%, the statement should be "less than 1/2 of 1%." If the scoring shows 1/2% or a fraction between 1/2% and 1%, the statement should be "less than 1%" except that on commodities such as grapes and citrus, where the tolerance is 0.5%, decay should be reported as "1/2 of 1%." Amounts between 1% and 1.49% should be reported as 1% and from 1.50 to 2.49% should be reported as 2%, etc. The expression "less than 2% decay" should not be used even though the grade involved may have a tolerance of 2% for decay or soft rot.
- (518) When decay is found irregularly in containers, this should be indicated by reporting the variations in general terms or by identifying marks. Examples:
1. In most boxes no decay, in some 4 to 12%, average 2% decay.
 2. In most boxes less than 1/2 of 1% to 1% decay, in Hyland Kid mark, manifested as 100 boxes, 3 to 10%, average 4% decay.
- (519) When no sample exceeds the decay tolerance, it is permissible to report the containers showing decay and those showing no decay in general terms without stating an average. Example of lettuce in cartons: "Most cartons no decay, some cartons 2% decay."
- (520) Determining Percentages of Decay When Specimens are Excessively Deteriorated. Frequently, when inspecting products on the basis of weight such as potatoes and onions, lots are encountered that have been in storage for relatively long periods. Such lots may contain material amounts of decayed specimens that are so completely deteriorated that

they have lost practically all or most of their original weight. Using the actual weight of these badly deteriorated specimens to determine the percentage of decay present would obviously give inaccurate results. In such cases the inspector should substitute, for weighing purposes, sound specimens that are approximately the original size of the deteriorated specimens. If this is impossible, the inspector should estimate the decay. When the product is freshly sorted or packed, this policy should not be followed but the actual decayed specimens should be weighed.

Latent Defects. Sometimes cases arise where the inspector knows (521) that a product is affected by some physiological or pathological condition which, though it may not be visible and cannot be suitably reported under any of the printed headings on the certificate, may cause serious deterioration in transit or storage. If instructions covering such latent defects are not given in the appropriate products handbook, the inspector should consult the supervising inspector or the inspector immediately in charge. Records of such defects should always be kept on the inspector's notes even though not mentioned on the certificate. Often such defects, while of little importance as affecting appearance or waste, can be scored on the basis of damage to shipping or edible quality. Examples are tomatoes that have been exposed to low temperatures and commodities that have been harvested from fields known to have been badly infested with disease that usually causes the product to decay, such as Late Blight of potatoes and tomatoes and Purple Blotch of onions.

GRADE

Under the "Grade" heading a statement must be made of the facts determined by the inspection in terms of the U. S. Grades, state grades or other specifications, unless the certificate is restricted to reporting specific factors, such as condition, or unless no grade or specification is established for the commodity. (522)

A definite statement must be made to cover each lot that has been identified or described in the preceding portions of the certificate. (523)
This statement may be a grade name such as "U. S. No. 1;" a qualified grade such as "U. S. No. 1, 2 inches minimum" or "U. S. No. 1 Green;"

- 104 -

(524) Supplemental Grade Statements. A lot may meet the requirements of more than one grade and/or specification or standard, including export statements or marketing agreement and purchase program requirements. If requested by the applicant, or required by official instructions, the fact of the additional compliance should be reported under "Grade."

Examples:

1. Washington Fancy, also meets requirements of U. S. No. 1. Meets U. S. Condition Standards for Export. Apples covered by this certificate meet the requirements of the Export Apple and Pear Act. Meets Canadian Import Requirements.
2. Beauty Plums: U. S. No. 1; meet quality requirements of Marketing Order 88.

Santa Rosa Plums: Fails to grade U. S. No. 1 and to meet quality requirements of Marketing Order 88 account grade defects.
3. U. S. No. 1 - Standard Pack.
4. U. S. No. 1 but fails to meet requirements of Blue Sure-Good Brand account grade defects.

(525) Grade on Restricted Certificates. When the inspection and certificate is restricted to specific factors such as size and condition, no grade statement can be made as all factors affecting the grade have not been determined. In such circumstances, the "Grade" heading should be followed by x xs. Such statements as "Lot meets condition requirements of grade" are not to be made on certificates restricted to condition.

(526) When No Established Grade. If no grades have been established for a product, it should be described under the preceding headings and "No Established Grade" typed following the "Grade" heading on the certificate.

(526-a) * Reporting Grade on DPSC Inspections. DPSC officials have authorized *
* the use of brief grade statements on certificates issued to that Agency. *
* The identification number of the applicable Federal Specification shall *
* be included in the grade statement on original inspections covering car *
* and truck lots intended for delivery to DPSC. This number is included *
* as part of the specifications on the purchase order and is available to *
* the inspectors. The following examples are satisfactory: *

- * Celery: "Fed. Spec. HHH-C-191d, No. 1". *
- * Lettuce: "Fed. Spec. HHH-L-226d, No. 1". *
- * Potatoes: "Fed. Spec. HHH-P-622a, No. 1, Size A, 2 inches minimum". *
- * Lettuce: "85% Fed. Spec. HHH-L-226d, No. 1". *

* All certificates reporting a percentage of No. 1 quality must show *
* the range and average of defects in the body of the certificate. *

Certification of Shipper's Brand Grades. Some shippers of apples, pears, potatoes and a few other products have registered brands and have issued printed specifications for them. When properly registered with state authorities, they are not required to stamp the packages with state or Federal grades unless an Export Form Certificate is desired. In most cases these brand specifications correspond closely to certain state or Federal grades, but may have additional or higher requirements. When requests are received for the certification of shippers' brand grades, it will be satisfactory to certify on the basis of these brands, providing the inspector has been furnished a copy of the brand specifications. If the specification requires the product to meet a state or Federal grade with additional requirements above this grade, both grades should be mentioned. Thus: "Grades U. S. No. 1 and meets Blue Banner Brand specifications" or "Grades Washington Extra Fancy and meets Blue Banner Brand specifications." If the lot is to be certified on an Export Form certificate, the containers must be marked with a state or Federal eligible grade for export regardless of the brand. (527)

Grades Statements Qualified as to Size. The grade statement of some products is not complete without adding a statement as to size. The standards for other products permit variations from the minimum and/or maximum sizes established in the grades to be made at the applicant's option, also size classifications are included in some standards. In such instances the grade statement must indicate the minimum and/or maximum sizes or size classification on which the inspection was made and be supported by the description of size in the "Size" heading. The following classes are described: (528)

1. "Unless Otherwise Specified". This clause appears in the size requirements for potatoes, onions, strawberries and many other products (refer to U. S. Standards). In such cases, if a lot does not meet the size specified in the grade but does meet a smaller size, or if the applicant wishes to specify a smaller or larger minimum size, then this size must be included in the "Grade" statement. Example: Potatoes: "U. S. No. 1, 1-1/2 inches minimum" or "U. S. No. 1, 2-1/4 inches minimum." When the size is certified as meeting that required in the grade, it is not necessary to make a size statement in connection with the grade. (529)

- (530) 2. No Size Limitation Specified in the Grade. If there are no size requirements in the grade, the applicant may specify minimum and/or maximum sizes on which they wish the inspection to be made. In such cases, the specified sizes must qualify the grade statement, thus: Eggplant: "U.S. No. 1, 4 inches minimum;" Cabbage: "U.S. No. 1, 2 to 6 pounds."
- (531) 3. Small, Medium, Large, Very Large, Extra Large. Two or more of these size classifications are found in the standards for such products as cabbage, Bermuda onions and several other products (refer to standards). If there is no demand for the use of these classifications because the product is not commonly sized in the district, these general size terms need not be used on the certificate and minimum or minimum and maximum diameters, length or weight may be used instead. However, if the lot is marked on the basis of such size classifications, or if the applicant requests it, one or two of these terms, as applicable, should be included in the grade statement, thus: "Grade: U.S. No. 1, Small to Medium."
- (532) Specific commodity size classifications such as Size A and Size B of potatoes and Boilers of onions should be reported in connection with the grade if requested by the applicant or reporting them is a general practice in the area, providing the lot meets the specification.
- (533) 4. Size Marks Required on Containers by Standards. The grades for certain products, including apples, pears and peaches, (refer to standards) do not contain size specifications but the standards for these products require the size to be marked on the container. Size specifications are listed separately in the size standards for these products. The specified size or sizes of such products, when marked or requested by applicant, should be included under the "Grade" heading as well as being described under "Size:" thus (Apples): "Grade U.S. No. 1, 2-1/4 inch minimum" or "2-1/2 inches and up as marked." When the size is not marked on the container as in bulk fruit, and the applicant does not specify size, it need not be mentioned in connection with the grade, but must be described under the "Size" heading.
- (534) Special Grade Designations. Descriptive words, such as "Early" of apples, "Green" of celery, "Russet" of citrus fruit, "Green" of asparagus, "Juice," "Table" or "Sawdust Pack" of grapes, "Red" or "Mixed" of sweet peppers, etc., are as much a part of the grade name as the usual No. 1 or Fancy and must never be omitted where they apply. Examples: U.S. No.1 Mixed Peppers or U.S. No. 1 Green Cabbage. In stating a percentage of U.S. No. 1 quality, these designations should be shown as part of the grade statement, thus: "85% U.S. No. 1 quality Green, 2 pounds minimum," or "87% U.S. No. 1 quality Green, clipped to 16 inches."

When the grade is a state grade, the name of the state must be included as part of the grade. Examples: Washington Extra Fancy, Maine Super Spud Grade, Idaho Utility. (535)

Unclassified is not a grade (except in Juice Grapes). The term should not be preceded by a U. S. or a State designation. (536)

It is not necessary to use the word "consumer" in certifying grade under the consumer standards, although if the applicant requests it there is no objection to showing "U. S. Consumer Grade A" (or B). Usually only when instructed to do so by the applicant or the packages are marked with a consumer grade. Because a product is packed in a consumer size package does not mean the consumer grade must be used. On the other hand, the consumer grades may be used in certifying products packed in whole-sale containers if requested to do so by the applicant. (537)

Certifying Standard Pack, Standard Bunching, etc. in Grade Statement. (538)
The standards for several commodities include optional specifications for Standard Pack or Standard Bunches (refer to standards). If the applicant requests that the inspection be made on the basis of these additional optional requirements to the grade and compliance with the requirements is found, this should be stated in connection with the "Grade" statement, thus: U. S. No. 1, Standard Pack: U. S. No. 1, U. S. Extra Row Pack (Tomatoes): U. S. No. 1, Standard Bunches. If a lot fails to meet these optional requirements, no mention need be made of it on the certificate unless requested to do so by the applicant. The details indicating compliance with the requirements should be reported under the appropriate headings in the body of the certificate.

Use of "As Marked". When a lot contains more than one grade and the grades are marked on the containers, the statement "as marked" should follow the statement of the grades, thus: "U. S. No. 1 or U. S. No. 2 as marked;" "Washington Extra Fancy or Fancy or C-grade as marked." If there is only one grade reported on the certificate, it is not necessary to add "as marked". (539)

Certifying Combination or Commercial Grades. Except when the applicant requests the percentage of the higher grade to be shown, the lot or car should be reported by grade name only, as: "Combination U. S. No. 1 and U. S. Utility" or "Washington Combination Extra Fancy and Fancy" (apples); U. S. Commercial (potatoes and onions), etc., without any reference to the percentage of the higher grade. Where cars are sold to (540)

contain a larger percentage of the higher grade than the combination requires, this can be shown by a statement: "U. S. Combination with at least ___% U. S. No. 1 quality" or the percentage of the higher grade can be shown, thus: "U. S. Combination with ___% U. S. No. 1 quality." The percentage of the higher grade should be reported under the "Grade" heading rather than under the "Quality and Condition" heading when this percentage is to qualify the grade statement.

(541) U. S. Combination grades require a specified minimum average percentage of the higher grade with individual samples to be not more than 10% below this average. When a greater average percentage of the higher grade is specified by the applicant, the same policy as to minimum range applies. Should the range be more than 10% less than the higher average, a lower average 10% above the minimum range may be reported, or the actual average qualified by the maximum and minimum range may be reported. Example: (Pears with 45 to 90%, average approximately 70% U. S. No. 1 quality) may be reported either as "U. S. Combination, range 45 to 90% average approximately 70% U. S. No. 1 quality", or "U. S. Combination, average approximately 55% U. S. No. 1 quality".

(542) Reporting Lots That Are out of Grade. When lots fail to meet the requirements of the grade or specification on which the inspection was requested, the inspector has three alternatives, namely:

1. Report a percentage of U. S. No. 1 grade quality or lower grade quality "Fails to grade U. S. No. 1, but contains 85% U. S. No. 1 quality". This is the standard procedure in many shipping areas.
2. Certify the lot on the basis of the next lower grade, if any, or Unclassified, as: "U. S. No. 2, with approximately 75% U. S. No. 1 quality." This procedure is often followed where compulsory state grades are involved.
3. If the applicant does not request that either of the above procedures be followed, the lot should be reported as failing to grade, stating the reasons. Examples:
 - (a) Fails to grade U.S. No. 1 account of grade defects.
 - (b) Fails to grade U. S. No. 1 account undersize in few sacks.
 - (c) Fails to grade U. S. No. 1 account materially stained onions.
4. Certificates should not report statements under the Grade heading such as "U. S. No. 1, except for—" or "Meets Condition requirements of grade".

Reporting Percentages of U. S. No. 1 Quality. When a lot fails to meet the requirements of U. S. No. 1 grade, the percentage of U. S. No. 1 quality may generally be certified under the "Grade" heading. It should be particularly noted that the term "quality" as used here means that the given percentage meets the U. S. No. 1 grade requirements in every respect. There is no tolerance in the percentage for size, color, firmness or any other defect which is mentioned. The word "quality" must follow the grade name in these instances. Example: "85% U. S. No. 1 quality" and not "85% U. S. No. 1." (543)

When a lot fails to grade U. S. No. 1, the percentage of U. S. No. 1 quality is determined by subtracting from 100% the total of the percentages of defects, undersize, oversize and any special tolerances of the grade shown in the preceding headings on the certificate. When a percentage of U.S. No. 1 quality is to be stated, percentages must be reported under the "Size" and "Quality and Condition" headings instead of using the statements "within, well within or average within tolerance". (544)

Reporting Grade in Approximate Percentages. Under the "Grade" heading the percentage of "U. S. No. 1 Quality" must be reported in actual percentages found when these percentages are 85% or more. For less amounts of U. S. No. 1 quality percentages reported should be rounded to the nearest number ending in 0 or 5 and qualified by the word "approximately," thus: 74% and 77% would be reported as "approximately 75%." (545)

P.A.C.A. has ruled that cars certified as a percentage of U.S. No. 1 quality will not meet "good delivery requirements" if they contain decay at shipping point in excess of the tolerance. (546)

Where size (undersize and/or oversize) is a factor of grade or there is an additional tolerance for special defects, such as under-colored specimens of Italian prunes, discoloration of citrus fruits, etc., these must be added to the percentage of ordinary grade defects in calculating the percentage of U. S. No. 1 quality. Example: If a lot of Italian prunes showed 5% general defects, 8% undercolored prunes and 5% undersize prunes, the percentage of U. S. No. 1 quality is 82% (to be reported as "approximately 80".) (547)

In those commodities such as apples, pears, peaches and tomatoes, where size is not a factor of grade, off-size should not be included when determining the percentage of U. S. No. 1 quality. Also, when the (548)

defect is to be scored on a definition of damage to the lot as a whole as in the case of punctures $1/8$ to $3/1$ inches in diameter on pears, the percentage of this type of defect should not be included in determining the percentage of U. S. No. 1 quality. When a lot is out of grade due to damage to the appearance of the lot as a whole, no percentage of U. S. No. 1 quality may be reported.

(549) Grades With "Unless Otherwise Specified" Clauses. In the case of a commodity with a grade that provides for a certain size unless otherwise specified, the percentage of U. S. No. 1 quality may be computed on more than one base. For example: U. S. No. 1 Topped Carrots, which unless otherwise specified requires a minimum diameter of $3/4$ inch and a maximum diameter of $1-1/2$ inches. A lot which shows 10% under $3/4$ inch, including 5% under $5/8$ inch, and 10% over $1-3/8$ inches, none over $1-1/2$ inches, also 15% defects, may be certified as follows under "Grade":

75% U. S. No. 1 quality; or, 80% U. S. No. 1 quality, $5/8$ inch minimum; or, 65% U. S. No. 1 quality, $1-3/8$ inches maximum diameter; or, 70% U. S. No. 1 quality, $5/8$ inch minimum diameter, $1-3/8$ inches maximum diameter. This same principle applies to certification for other "Unless otherwise specified" requirements such as that for trimming in the standards for Broccoli, stalk length having green color in Asparagus, length of cob in green corn, size of potatoes and onions, etc.

(550) When Percentage of U. S. No. 1 Quality Below 50%. It is not necessary to show less than 50% U. S. No. 1 quality unless requested by the applicant to do so. When the percentage is lower than this, the lot may be reported as U. S. No. 2 or Unclassified, or as fails to grade U. S. No. 1 account-----.

(551) Container Tolerances Do Not Limit Percentage of U. S. No. 1 Quality. Lots certified as a percentage of U. S. No. 1 quality are not limited by a minimum range such as "1-1/2 times the tolerance" because such average percentages are not established grades. This does not apply to Combination grades and Commercial grades when the percentage of defects permitted in individual containers is limited.

- 111 -

High Percentages of U. S. No. 1 Quality. Certificates some- (552)
times show average percentages of U. S. No. 1 quality that are higher than
that required by the grade. This occurs when samples generally are well
within tolerance but a few samples are found that exceed the container
tolerance thus putting the entire car out of grade. For example: A lot of peas
where 18 samples examined ranged from 2 to 5% defects and two samples show 20%,
averaging 4%. This lot would be reported as "Average 96% U. S. No. 1 quality".
A similar situation occurs when defects are within tolerance but decay exceeds
the tolerance either as to average or to container tolerance.

Serious Defects of a Progressive Nature Must be Reported in (553)
Connection With Grade Statements on Percentage Lots. In order to make it
more convenient for the seller to furnish to buyers important information
as to condition, the statement under "Grade" on percentage lots must show
following the percentage of U. S. No. 1 quality, and any qualifying
statement as to size, etc., the average percentage of decay and any other
serious defects of a progressive nature if they exceed the grade toler-
ance. For example: "Approximately 85% U. S. No. 1 quality, 2 inches
minimum, 4% soft rot." The percentage of decay and other serious defects
of a progressive nature will also be shown in the "Grade" statement when
they are within the grade tolerance if the range of such defects in any
sample exceeds the variations permitted in the application of tolerances.
In this case the average and the fact that such defects are irregular must
be reported in the "Grade" statement. For example: "Approximately 85%
U. S. No. 1 quality Green; decay irregular, average 1%". Decay and
other serious defects of a progressive nature will not be shown under
"grade" when they are within the grade tolerances and they do not exceed
the variations permitted in the application of the tolerances.

The following are defects of a progressive nature which must (554)
be reported in connection with the grade as well as being reported and
described under the "Condition" or "Quality and Condition" headings on
the certificate when the defects are serious enough to score against the
grade on which they are being certified and they exceed the tolerance in
the grade under which they are scored:

All Commodities - - - - - Decay and soft rot limited by
special tolerances in the grades.
Wet breakdown following freezing,
overripe, flabby.

Cantaloups- - - - -	Soft, free liquid and seeds.
Cauliflower - - - - -	Spread, yellow jacket leaves.
Celery- - - - -	Blackheart, Brown Stem.
Citrus - Florida & Texas- - -	Skin breakdown.
Cucumbers - - - - -	Anthrachnose, shriveled ends.
Garlic- - - - -	Waxy Breakdown.
Onions- - - - -	Breakdown, sprouts.
Peaches - - - - -	Soft.
Peppers - - - - -	Shriveling.
Potatoes- - - - -	Mahogany Browning, Internal Black Spot, Net Necrosis, sticky, sunken discolored areas.
Tomatoes- - - - -	Soft, virus mottling, sunken dis- colored areas, Internal Browning.
Watermelons - - - - -	Anthrachnose.

(555) Unless amended at a later date, the above list includes all of the factors which are considered defects of a progressive nature that should be reported in connection with the grade on percentage of grade quality certifications. It must be remembered that it is the intent to include only those factors which are considered serious from the standpoint of their progressive deterioration and that no consideration should be given as to whether or not a defect is listed as serious damage in our grades.

(556) Reporting Percentages of U. S. No. 2 Quality. When a lot of product for which there is a U. S. No. 2 grade fails to meet the requirements of this grade, it is satisfactory to report a percentage of U. S. No. 2 quality if it is a product for which it is a commercial practice to pack the U. S. No. 2 grade, such as oranges and tomatoes. Reporting a percentage of U. S. No. 2 quality is not advisable in case of a product for which this grade is not generally packed. The following three methods may be used in making the grade statement for products which fail to meet the U. S. No. 2 grade requirements:

1. Show the percentage of U. S. No. 2 quality.
2. State that it fails to grade U. S. No. 2 account of -----.
3. Certify as Unclassified.

Reporting Percentages of U. S. Fancy Grade. It is our usual policy (557) not to certify percentage of U. S. Fancy quality if stock fails to meet U. S. No. 1 grade.

Instructions for Reporting U. S. Fancy and U. S. No. 2 Quality. The (558) principles and instructions that apply to reporting U. S. No. 1 quality generally also apply to reporting U. S. Fancy and U. S. No. 2 quality. Usually 85% U. S. No. 2 quality will be as low a percentage of quality as should be reported. Circumstances such as heavy percentages of defects not causing serious damage or requirements of purchase programs may, however, warrant reporting a lower percentage. Even in such cases less than 75% U. S. No. 2 quality should not be reported, except on special request, because a lot grading less than this would be of such poor quality that the percentage would be of little or no significance.

Certifying Percentage of Grade A Quality on Consumer Grades. On most (559) commodities there is no objection to certifying a percentage of U. S. Grade A quality when the product is packed on the basis of the consumer standards providing the packages are not labeled as to grade.

Determining Weighted Averages of U. S. No. 1 or Other Grade Quality. (560) In many loads of such products as strawberries, where the size of the lots in the load as well as the percentage of U. S. No. 1 varies, only weighted averages of U. S. No. 1 quality will be accurate.

To determine the weighted average percentage of U. S. No. 1 quality (561) on irregular size lots showing a wide variation in percentage of U. S. No. 1 quality, first determine the average percentage of U. S. No. 1 quality in each lot in the usual way. Then multiply these average percentages by the number of containers in each lot. Total these figures and divide the total by the number of containers. Thus:

20 crates x 60% U. S. No. 1 quality	_____	1200
100 crates x 50% U. S. No. 1 quality	_____	5000
5 crates x 90% U. S. No. 1 quality	_____	450
10 crates x 95% U. S. No. 1 quality	_____	950
	<hr/>	
135		7600

$7600 \div 135 = 56\%$ U. S. No. 1 quality which should be reported as approximately 55% U. S. No. 1 quality. This gives due weight to the number of packages which show the different percentages of U. S. No. 1 quality.

- (562) Reporting Overgrade Stock in a Lot. If a lot is packed or marked to meet U.S. No. 2, but grades 25% or more U.S. No. 1 quality, then the percentage of U.S. No. 1 quality may be reported, especially if requested by the applicant. This information should follow the "Grade" statement thus: "U.S. No. 2 with approximately 35% U.S. No. 1 quality." Mention of less than 25% generally should not be made as a small percentage of over-grade specimens is to be expected in any U.S. No. 2 pack.
- (563) If the product is one for which no grade is provided below U.S. No. 1, as is the case with many green vegetables, or if the lot is Unclassified, it usually will not be desirable to show less than 50% U.S. No. 1 quality.
- (564) When a lot is certified as Unclassified, the proportion of U.S. No. 1 quality may be shown under the "Grade" heading and the proportion of defects affecting U.S. No. 2 grade reported under the "Quality and Condition" heading.

Example:

Q&C: Grade defects affecting U.S. No. 2 range from 20 to 45%, average 35%, consisting mostly of -----."

Grade: Unclassified. Approximately 40% U.S. No. 1 quality.

- (565) If there is no grade for the product below U.S. No. 1, the "grade defects" statement will be the same as for any lot which fails to meet U.S. No. 1 and the percentage of U.S. No. 1 quality may be reported under the "Grade" heading.
- (566) When a Lot Meets a Higher Grade Than Marked. When an inspection of a lot is requested on the basis of U.S. No. 1, but the lot is found to meet the requirements of U.S. Fancy, U.S. Extra No. 1 or a Combination U.S. Fancy and U.S. No. 1, it is not necessary to mention this factor.

REMARKS

- (567) At shipping point there usually is no need for a "Remarks" heading on the certificate and none has been printed on the long form. However, in some instances it is necessary to make explanatory or qualifying statements or to furnish information that the inspector is unable to personally certify to or that does not fall into the category of any of the usual certificate headings. Under such circumstances, a "Remarks" heading should be typed in near the bottom of the certificate following the "Grade" heading. Under this heading the following and similar information should be reported:

(1) The car or truck license number when the inspector does not see the lot loaded and the number is supplied by the applicant. Example: (569)

Applicant states lot loaded into car PFE 54321.

(2) Cross reference certificate numbers when two or more certificates are issued covering the same car. Examples: (569)

(a) Inspection of pears in this car reported on certificate number A-97452.

(b) Inspection and certificate restricted to condition only, lot previously inspected for quality and condition on _____ and reported (Date) _____

on certificate number _____.

(3) Statements that the certificate has been corrected. Example: (570)
This is a corrected certificate that supersedes certificate No. _____.

(4) Storage or warehouse lot numbers and purchase order number that are not quoted from marks on the containers but are supplied by the applicant or storage. Examples: (571)

(a) Star Cold Storage Co. records show lot stored under their warehouse number 45321.

(b) Applicant states lot covered by purchase order OAK-13254.

(5) Truck license numbers when a large lot being moved by various trucks is certified on one certificate and the applicant requests the license numbers be reported. (572)

(6) Restrictive statements as to loading, condition, size, certain marks, etc. See following paragraphs. (573)

RESTRICTED CERTIFICATES

Restricted certificates generally fall into one of two classes: (574)

(1) restrictions to a portion of a lot or load and (2) restrictions to specified factors describing the product.

- (575) (1) Occasions arise where the inspector is not able to make an inspection of all parts of the load. If the car is already partly or fully loaded and the applicant is not willing or is unable to make all parts accessible for proper sampling, or if the inspector is unable to inspect the last of the load placed in the car due to the car having been pulled in their absence, or for other reasons, do not hesitate to issue a restricted certificate covering only that part of the load which was sampled. Also, when making inspections of lots in storage, all portions of the lots must be accessible for sampling, otherwise the certificate must be restricted to the portion that is accessible, such as the upper three layers or the front three stacks of warehouse piles. If such restrictions do not appear on the certificate, it will be assumed the inspection covered the entire lot and the inspector will be held responsible for any errors resulting.
- (576) Restrictions to a portion of a load or lot because of being inaccessible weakens a certificate. Every effort should be made to sample the entire lot or car, either by the inspector's efforts if practical, or with the shipper's cooperation if possible, in order that restricted certificates may be kept to a minimum.
- (577) The "Remarks" statement on the certificate must state clearly what portion of the lot is covered by the certificate. The statement "restricted to accessible portion of load" alone is not satisfactory. The portion of the load or lot covered by the certificate must be specified by reporting the layers, stacks, and/or rows sampled or by reporting identifying marks such as brands, grades, varieties, etc. The restricting statement must also include the reason for the restriction.
- (578) When the car is fully loaded at time of inspection and the certificate is restricted to the accessible portion, such as the upper layers or the stacks nearest doors, or to upper layers or front stacks, etc., of warehouse lots, the count to be reported under the "Products" heading is that of the entire load or lot. Under all other circumstances, such as restrictions to portions of loads in ends of cars (the remainder having been loaded after inspector leaves) and restrictions to specified commodities, varieties, grades, brands, marks, etc., the count to be reported is that of the portion of the load or lot actually sampled (usually such restrictions are at the applicant's request).

Examples:

(5/9)

Car Fully Loaded at Time of Inspection:

Products: ----- (including count of entire load)
----- See "Remarks".

Remarks: Certificate restricted to accessible upper 3 layers of Load. Car loaded at time of inspection.

or: Certificate restricted to accessible 2 stacks each side of centerbracing. Car loaded at time of inspection.

or: (Bulk Load) Certificate restricted to upper 2 feet of load. Car loaded at time of inspection.

or: (Warehouse storage lot) Certificate restricted to front 2 stacks and upper 3 layers of warehouse pile, remainder inaccessible.

Last of Loading Not Inspected. In any case where the inspector (580) cannot remain until a car is completely loaded, the certificate must show under the heading of "Loading" the exact condition of the load as last seen by the inspector, and not as it is expected to be when finished. Cases have occurred where the stock for the car was all set out and available for inspection, but the loading was changed, and in some instances different stock was substituted after the inspector's departure. Receiving point discovery of such a situation as this seriously discredits the shipping point service. The number of packages shown under the "Products" heading should be the number in the car when the inspector leaves - Example:

Products: - - - - - 425 packages. See "Remarks".

Loading: - - - - - at completion of inspection 10 stacks A end of car, 7 stacks B end, 5 rows, 5 layers, each layer stripped.

Remarks:- - - - - 75 packages on floor of packing shed of same lot as that covered by this certificate, and of same grade and condition, which applicant states will be loaded in space between doors.

(581) Or, if the packages which the applicant states are to complete the load are not available, the statement under the heading "Remarks" should be: "Certificate restricted to the 465 packages in car at completion of inspection. Inspector unable to examine last of lading before car was pulled".

(582) Restricting Certificate to Certain Marks, Varieties or Grades. In some cases the inspection may be requested to cover only a certain lot or lots in the car. The number of packages inspected should be shown under "Products". It is only necessary to show the loading of the products inspected, however, the complete loading of the car may be shown opposite "Loading" if desired.

Example:

Products: Fresh Peas, 160 crates, labeled-----.
See "Remarks".

Loading: Crates of peas in B end of car 8 stacks, 5 rows,
4 layers, each layer stripped. Remainder of
load is cabbage. Divided load, centerbraced.

Remarks: Certificate restricted to peas in car. Manifest
shows 120 crates cabbage also in car.

(583) Under the heading "Remarks" should be reported (1) that part of the load to which the inspection and certificate is restricted, and (2) when readily available, the number of packages and kind of the product also in the car but not inspected. The latter information is for statistical purposes and should be quoted from the manifest. Cases arise where for clarity of the certificate itself, it is best to show both the part of the load which is covered by the certificate and that which is not, particularly where one portion of the load shows marks which are not conspicuous.

(584) Restricting Certificates to Certain Points. Under certain circumstances the inspection may be restricted to condition, net or gross weight of containers, size, temperature, Standard Pack, count or weight of specimens. In such cases, the certificate must be restricted. For example: (1) "At applicant's request inspection and certificate restricted to condition only." (2) "At applicant's request inspection and certificate restricted to net weight only".

*
*
*
*
*
*
*

*
*
*
*
*
*
*

* Restricting inspection to one factor of quality or condition is not (585).*
* permitted. Restricting to one factor may result in misunderstanding *
* as to whether or not the lot may be in or out of grade. *
*

Certificates restricted to one factor of quality, such as solidity (586)
of lettuce or color of apples; are usually undesirable. Such certifi-
cates may be issued only with the permission of the Washington office.
When requests are received for such restricted inspections, consult your
Federal supervisor.

CONTINUOUS INSPECTION

The Regulations governing the inspection and certification of fresh (597)
fruits, vegetables and other products provide for a continuous inspection
service associated with the use of the approved grade shield, the approved
continuous inspection marks, or both, on the container. This service may
be supplied either at shipping point or receiving market whenever inspectors
are available, the facilities and conditions are satisfactory for the service,
and there is a signed contract between the applicant and the Department,
or a cooperative Federal-State Inspection Agency in which it is agreed
that such service will be conducted subject to the regulations governing
the inspections of fresh fruits, vegetables and other products, and any
additional and supplemental instructions issued by the Department or such
instructions issued by a cooperating agency which are not inconsistent with
those issued by the Department. These regulations also cover such points
as survey of the plant and premises, equipment, operations and operating
procedures, and termination of the contracts. The inspectors, as well
as applicants, must be fully advised regarding these details, because they
will be made a part of the contract by reference to the Regulations, thus
simplifying contracts. (See Sections 51.57 and 51.59 to 51.66 of the
Regulations). Requests for this service should be taken up with the
District Supervisor.

VISUAL AIDS

All Inspectors-in-charge and supervising inspectors to whom visual (598)
aid materials are assigned should take necessary precautions to protect
them from damage and from loss or theft. It should be noted that it is
in violation of Department Regulations to sell or give visual aids to
private parties.

* * * * *

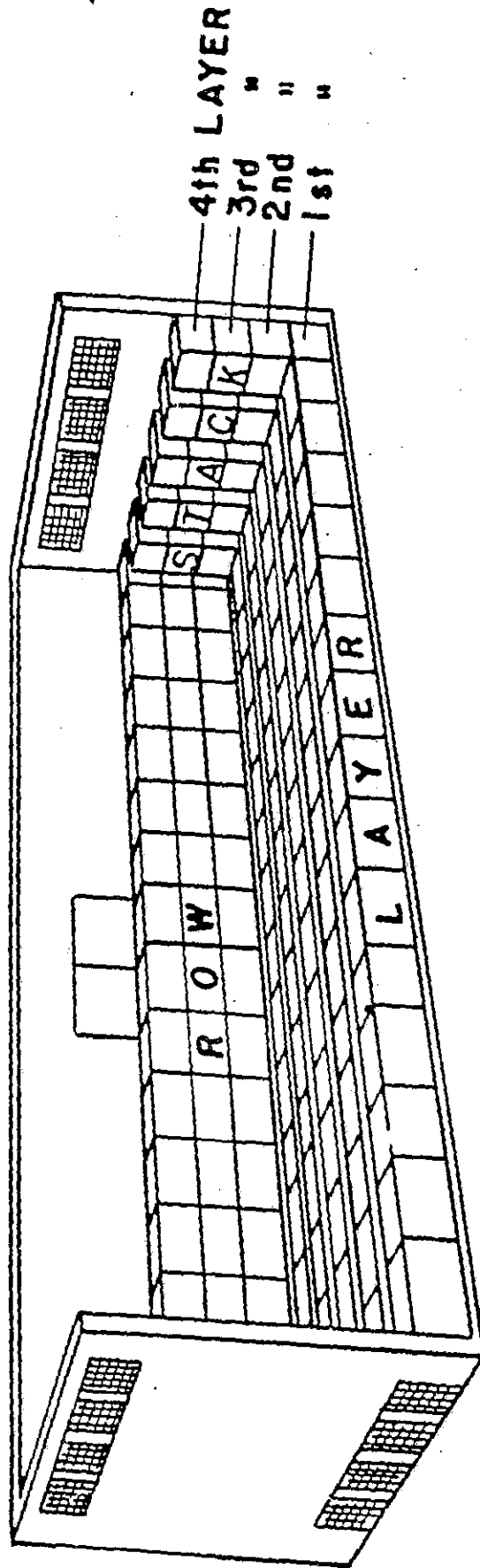
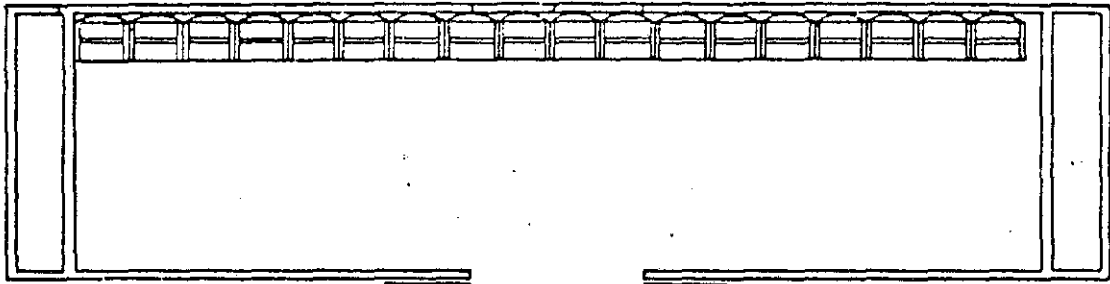
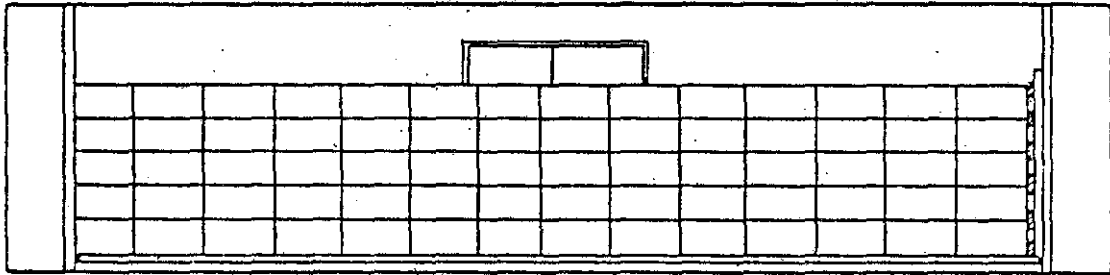

Plate I



GUIDE ROW



THROUGH LOAD

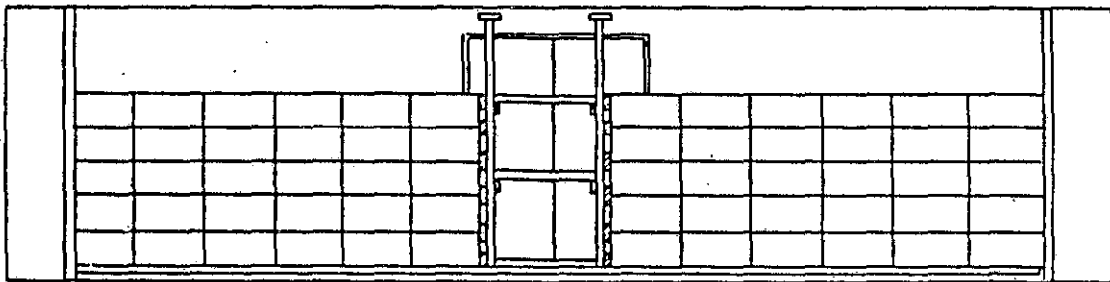

DIVIDED LOAD

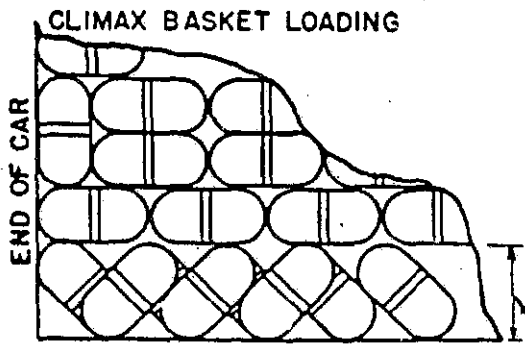

DIAGONAL ROW

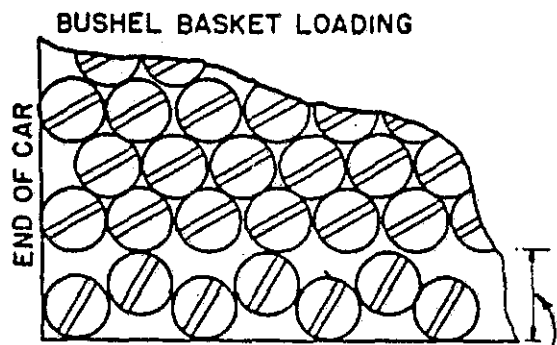

STAGGERED ROW

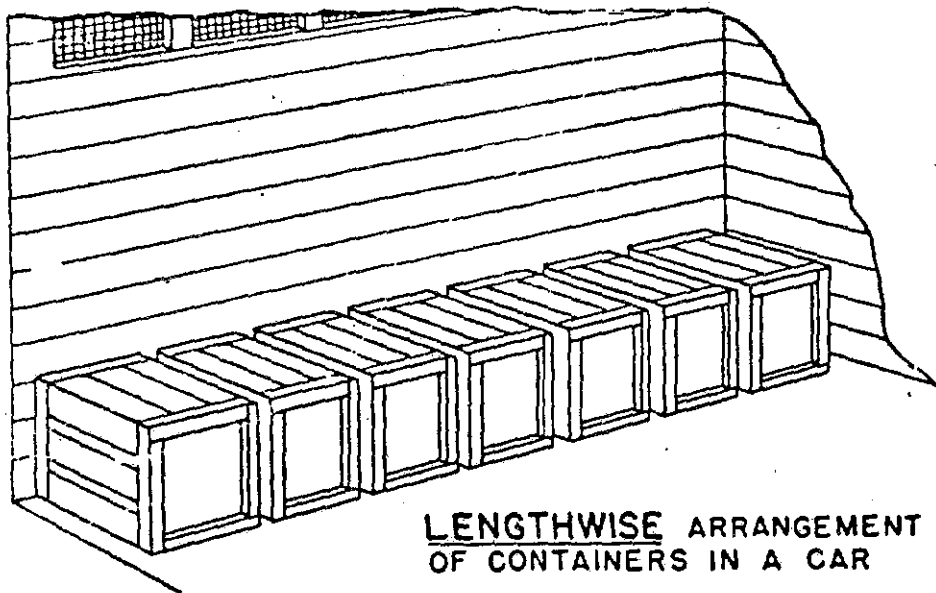

**LENGTHWISE ARRANGEMENT
OF CONTAINERS IN A CAR**

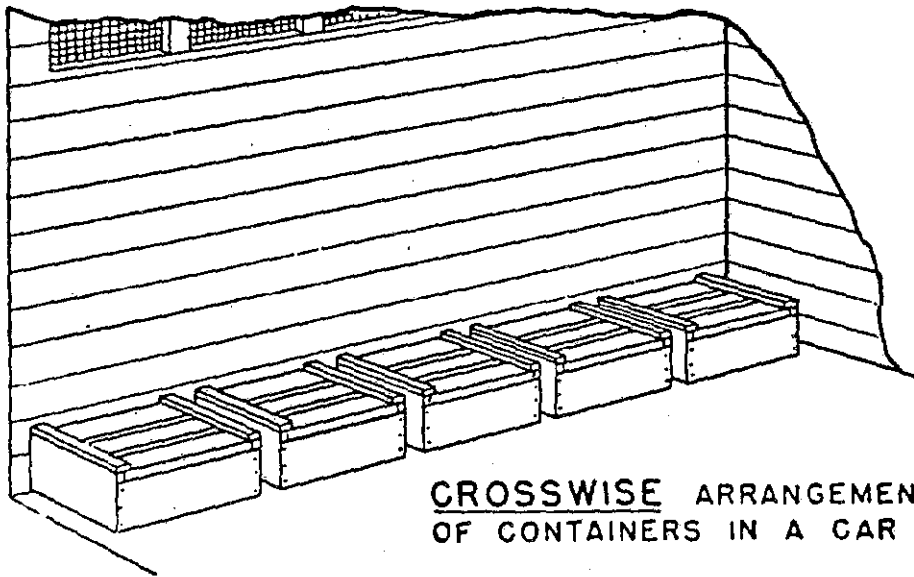

**CROSSWISE ARRANGEMENT
OF CONTAINERS IN A CAR**

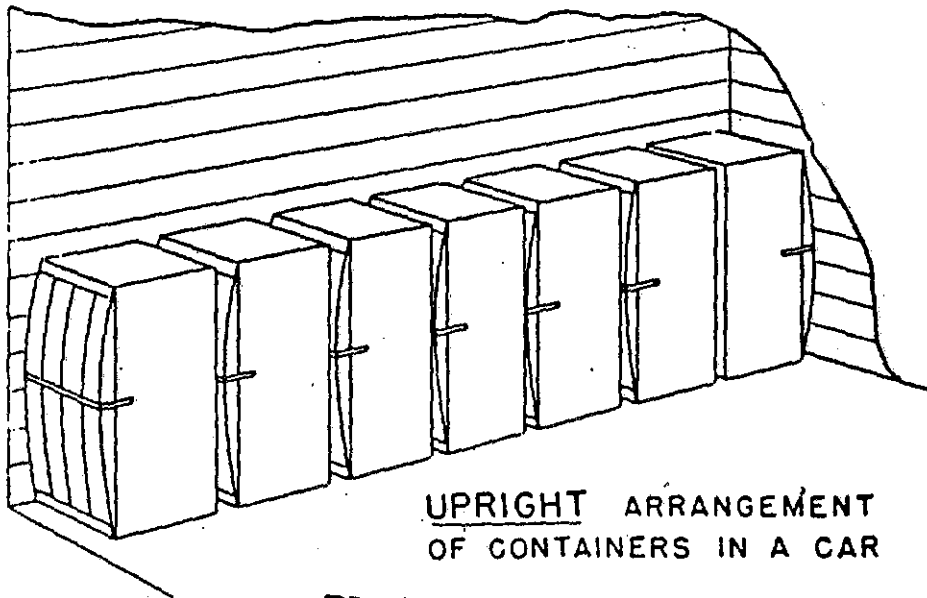

**UPRIGHT ARRANGEMENT
OF CONTAINERS IN A CAR**

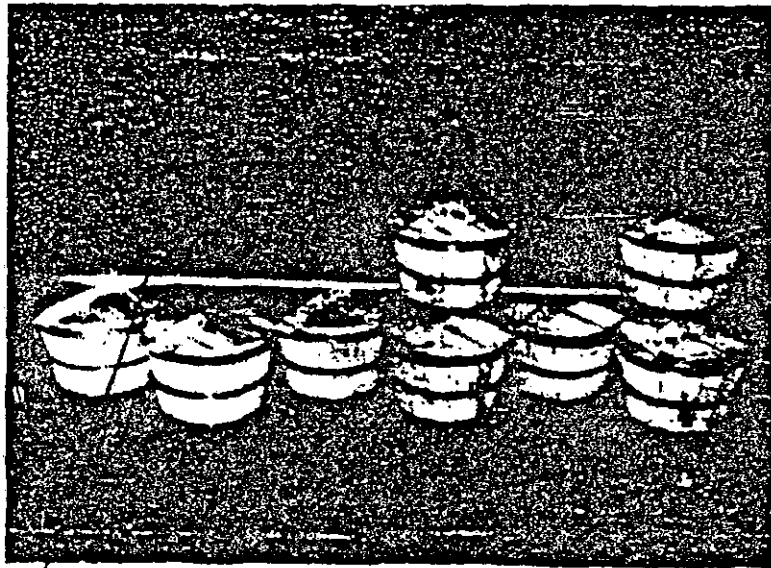
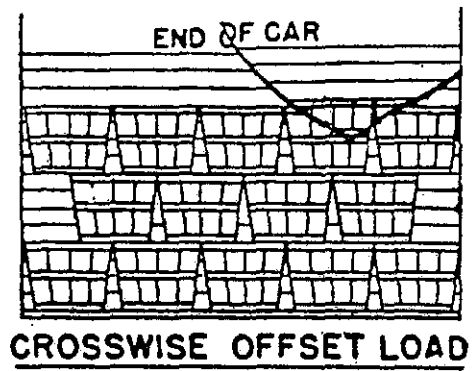
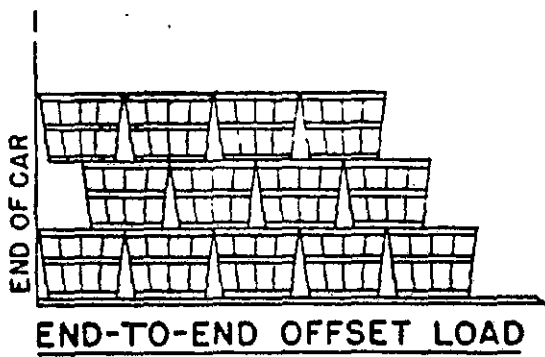

END BOARD FOR BASKET LOADS

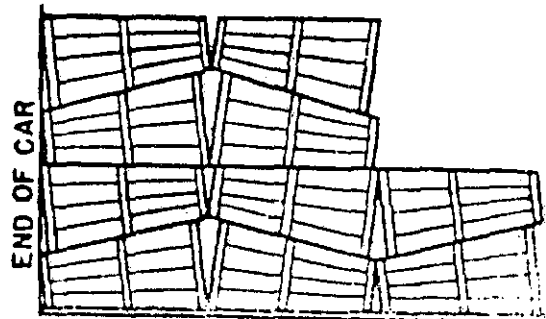
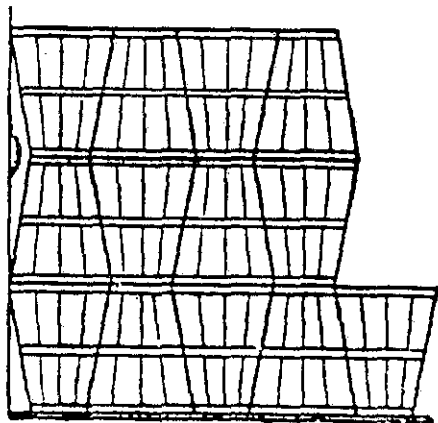

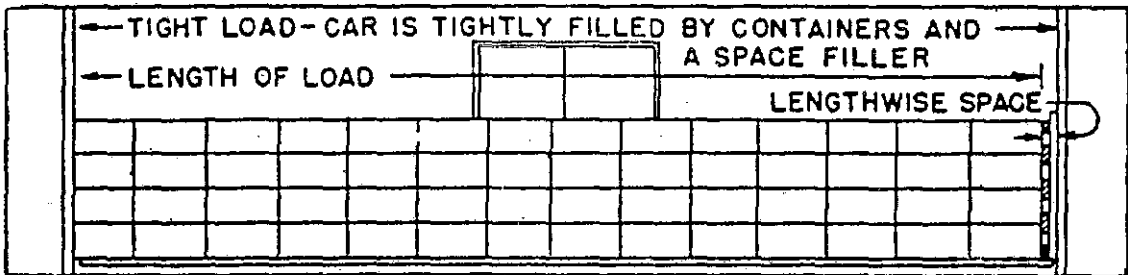

LENGTH OF LOAD
LENGTHWISE SPACE
TIGHT LOAD

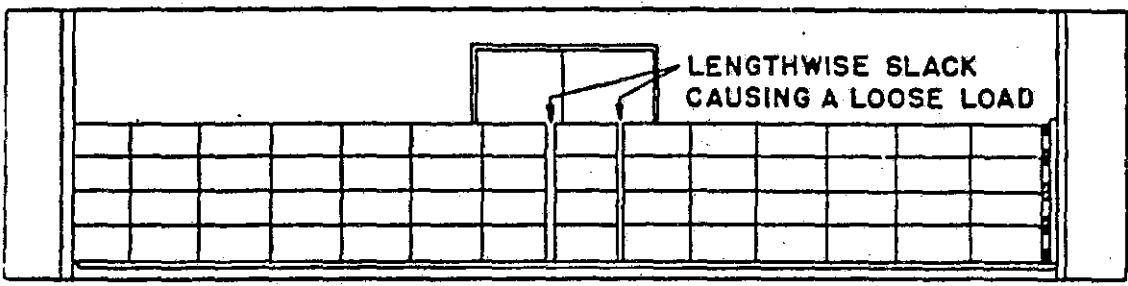

LENGTHWISE SLACK
LOOSE LOAD

Plate V

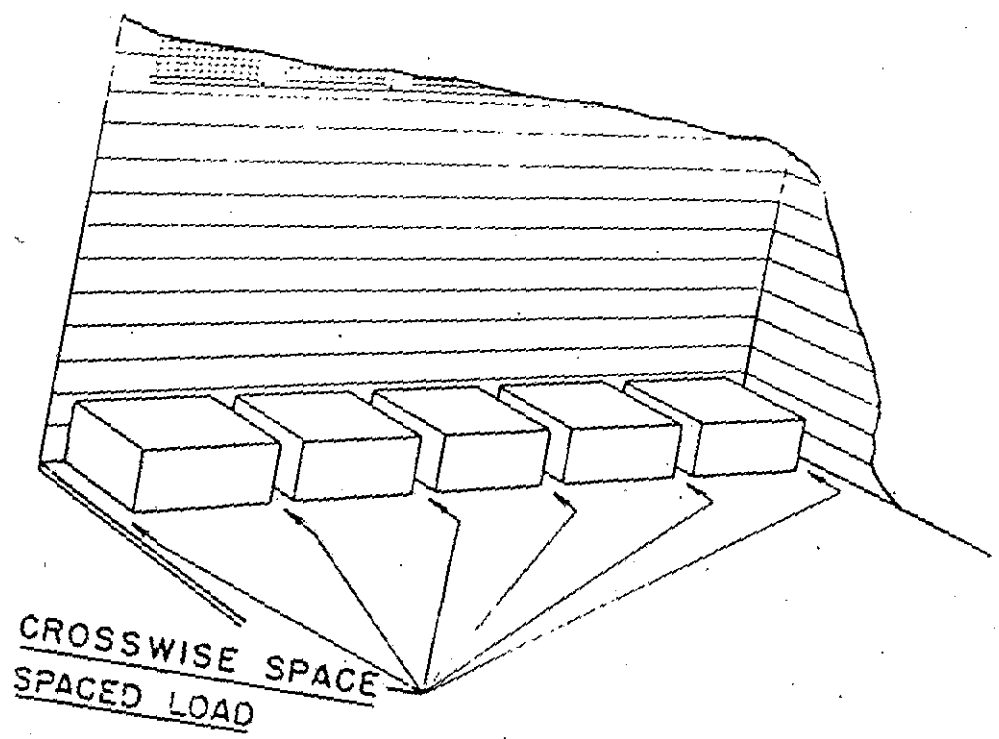

CROSSWISE SPACE
SPACED LOAD

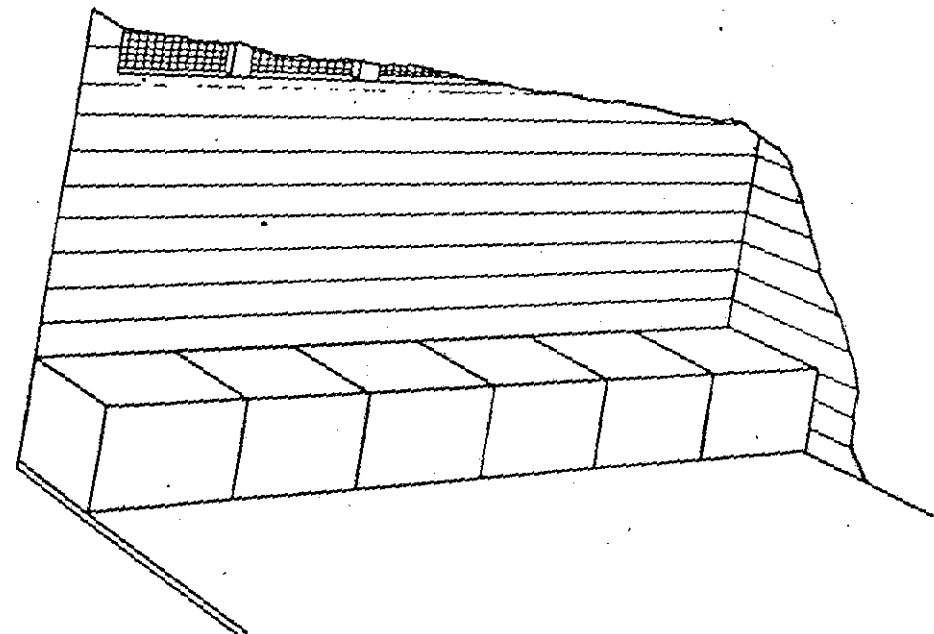

NON-SPACED LOAD

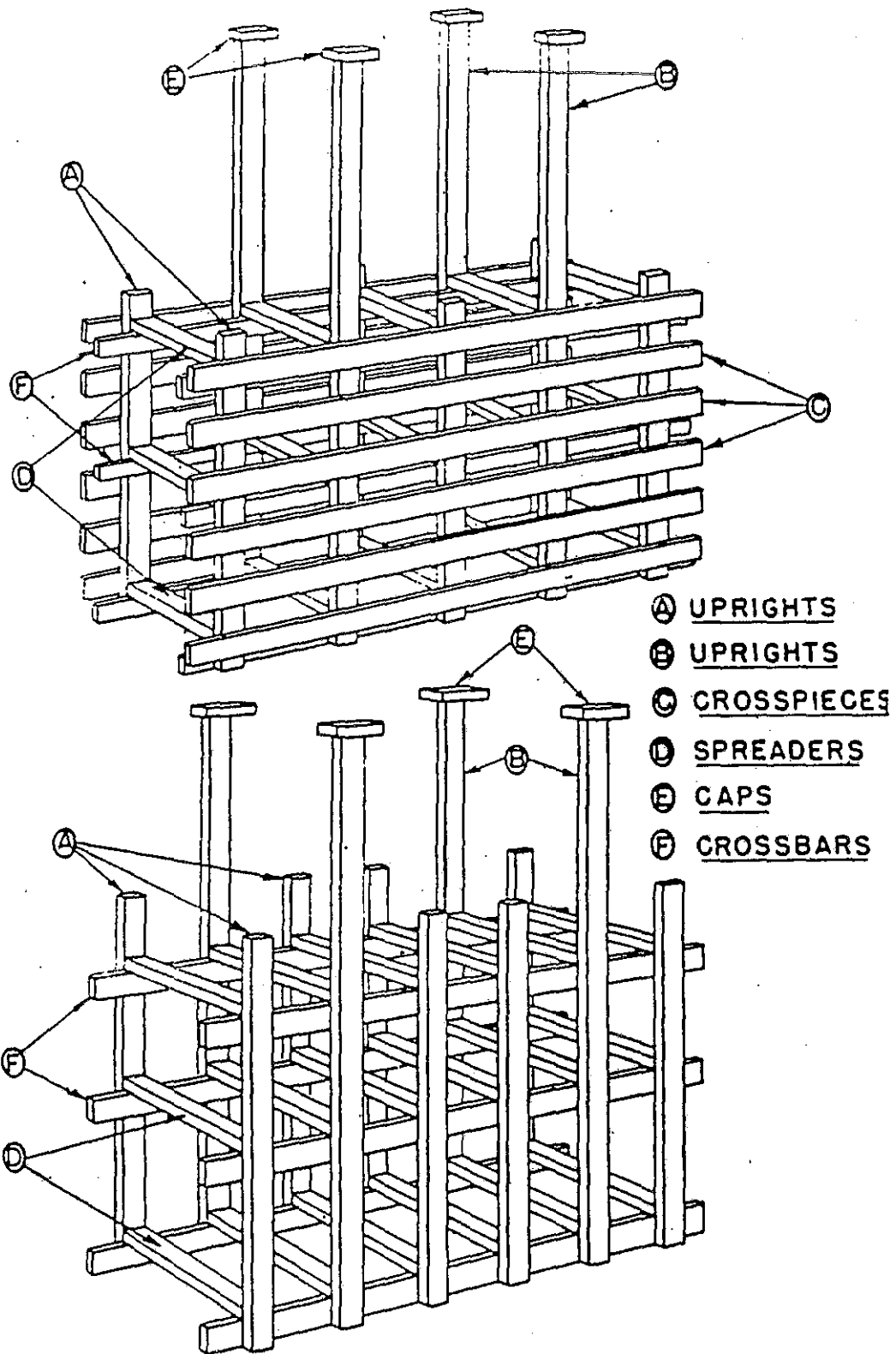

TWO TYPES OF CENTER GATES

Plate VII

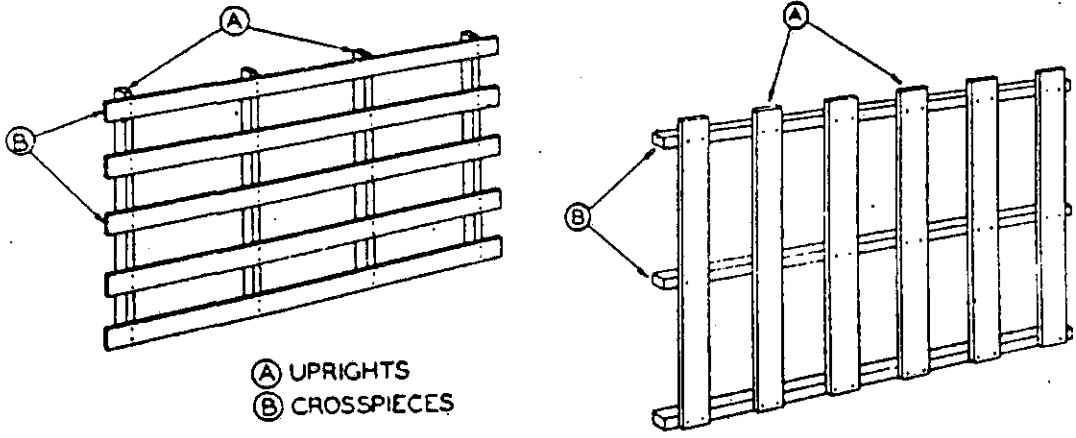

TWO TYPES OF END GATES

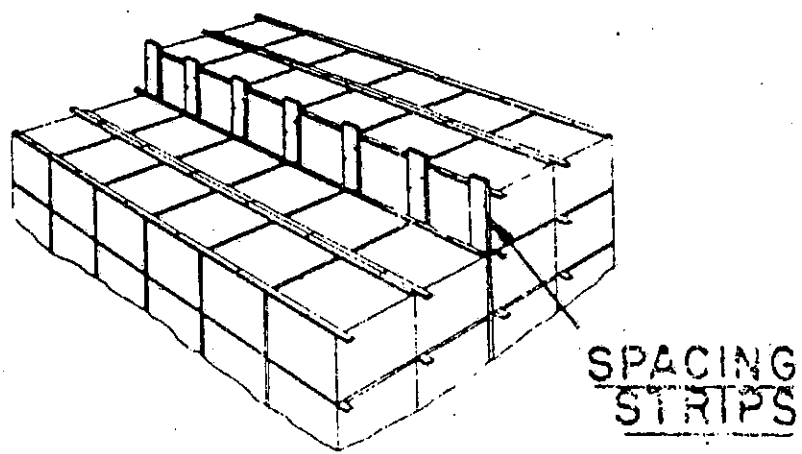
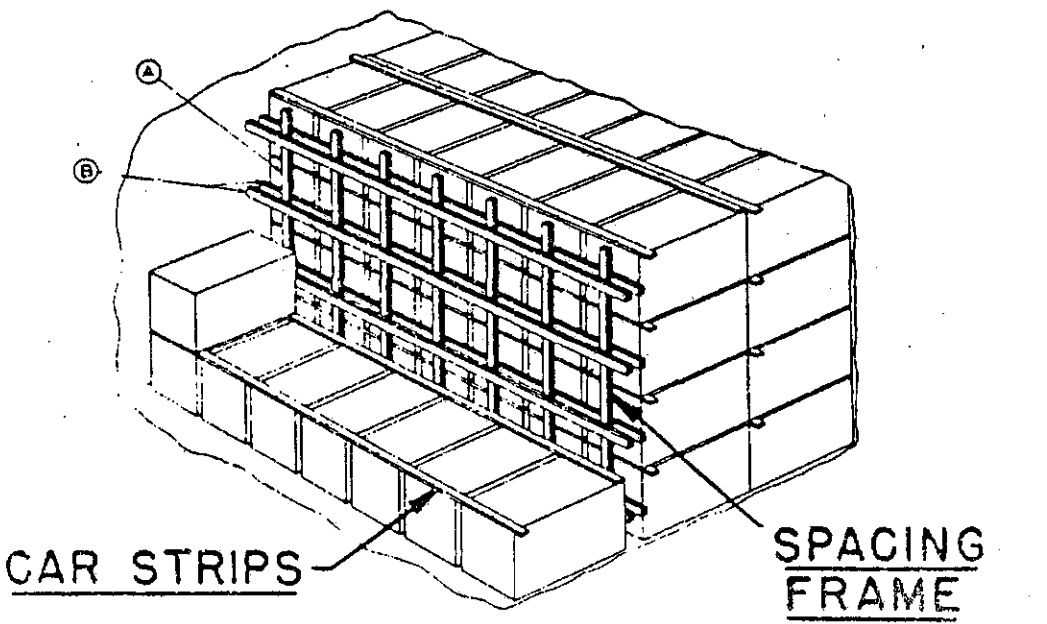
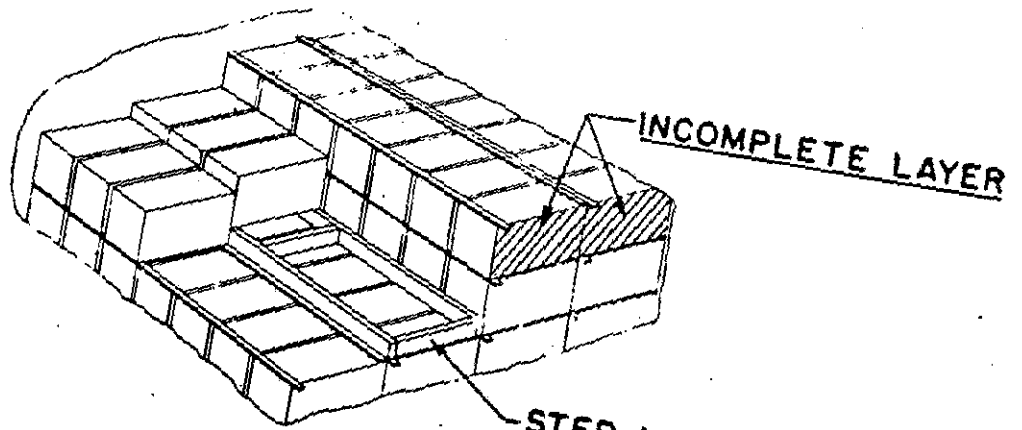
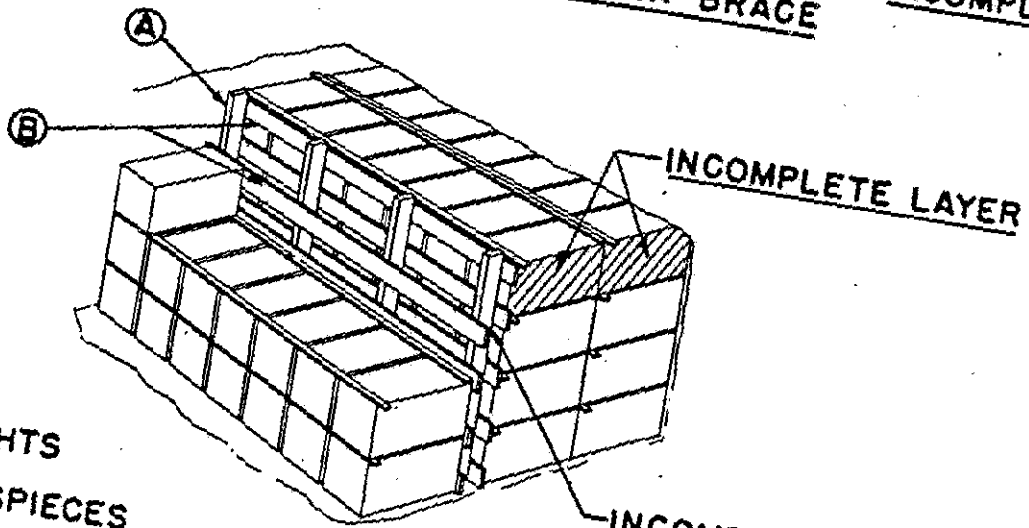

Plate VIII



STEP-UP BRACE WHICH IS ONE TYPE OF INCOMPLETE LAYER BRACE



INCOMPLETE LAYER

- (A) UPRIGHTS
- (B) CROSSPIECES

INCOMPLETE LAYER BULKHEAD

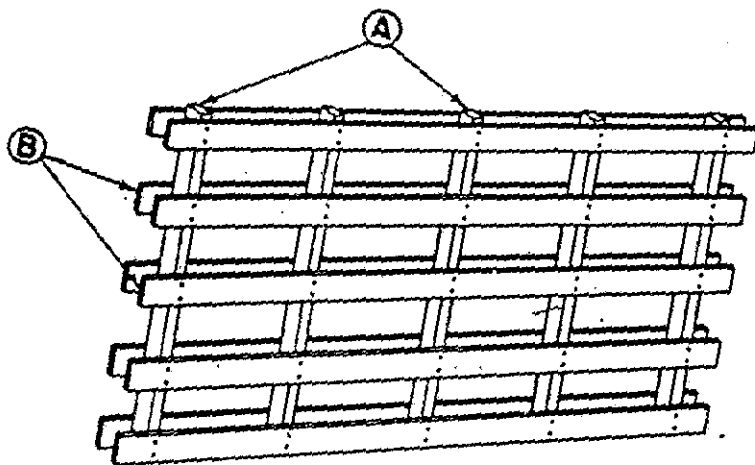

SEPARATING FRAME

Plate IX

THE MODERN REFRIGERATOR CAR

FEATURING AIR CIRCULATING FANS AND AUTOMATIC HEATERS

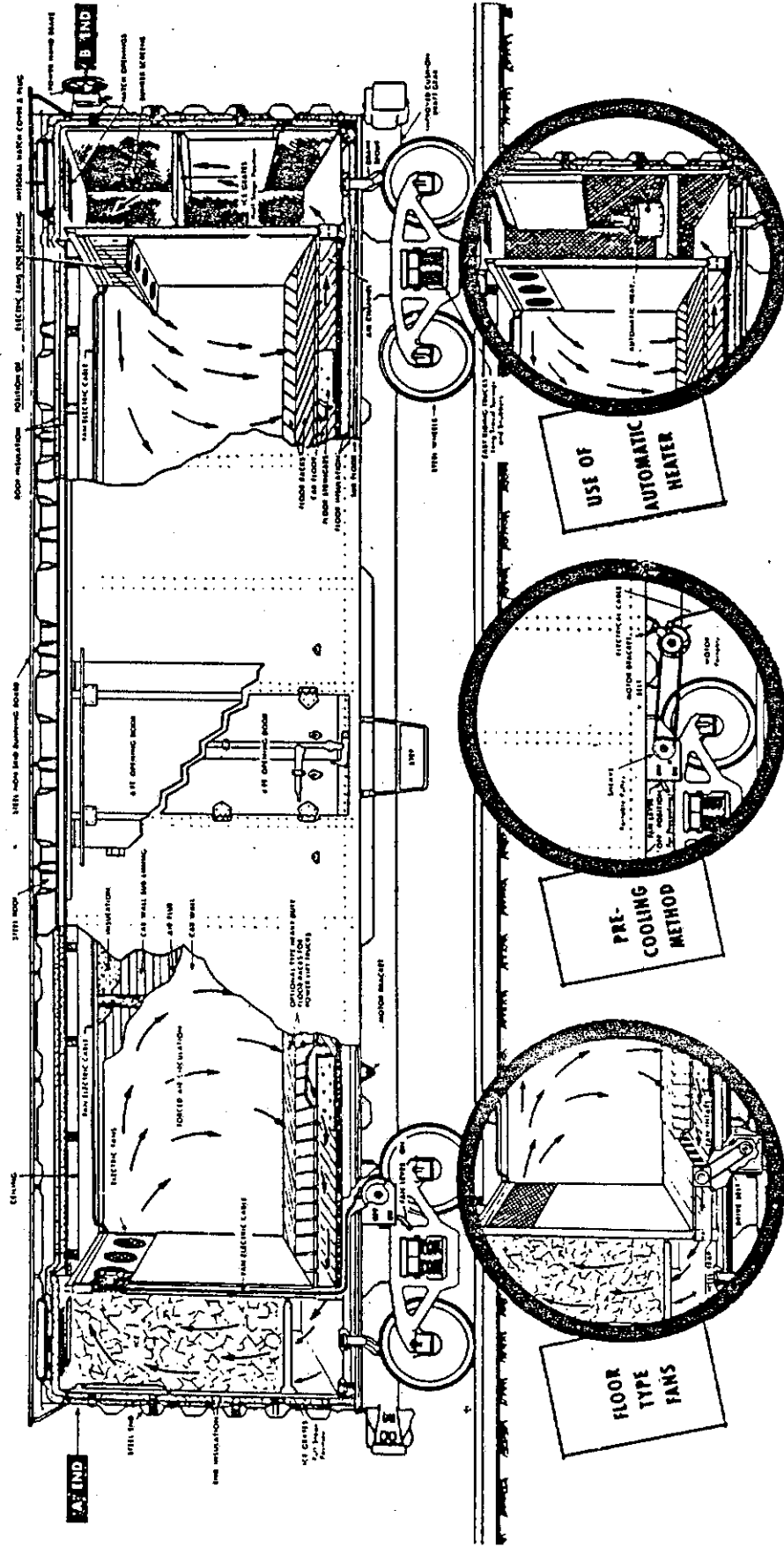

USE OF
AUTOMATIC
HEATER

PRE-
COOLING
METHOD

FLOOR
TYPE
FANS

